

# **dji** FLYCART 30

## Uncrewed Aircraft Flight Manual

v1.0 2024.01

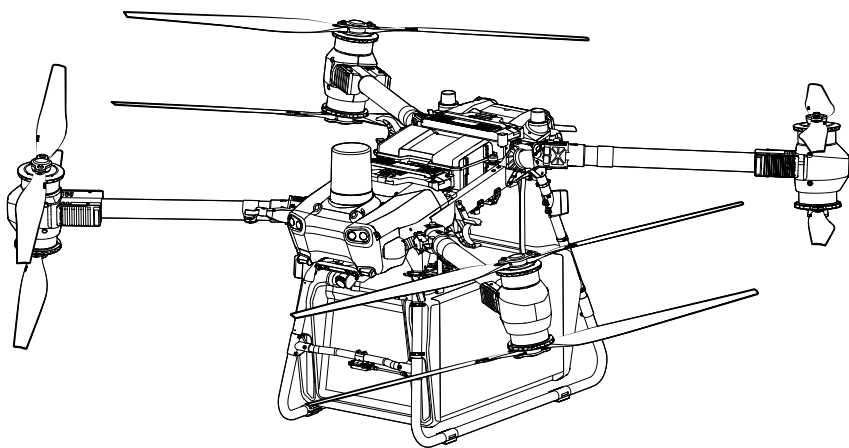



This document is copyrighted by DJI with all rights reserved. Unless otherwise authorized by DJI, you are not eligible to use or allow others to use the document or any part of the document by reproducing, transferring or selling the document. Users should only refer to this document and the content thereof as instructions to operate DJI UAV. The document should not be used for other purposes.

### **Searching for Keywords**

Search for keywords such as “battery” and “install” to find a topic. If you are using Adobe Acrobat Reader to read this document, press Ctrl+F on Windows or Command+F on Mac to begin a search.

### **Navigating to a Topic**

View a complete list of topics in the table of contents. Click on a topic to navigate to that section.

### **Printing this Document**

This document supports high resolution printing.

# Using This Manual

## Legends

⚠ Important

💡 Hints and Tips

## Before Flight

The following documents have been produced to help you safely operate and make full use of your aircraft:

1. In the Box
2. Disclaimer and Safety Guidelines
3. Quick Start Guide
4. User Manual (Uncrewed Aircraft Flight Manual)

Refer to the corresponding In the Box to check the listed parts and read the disclaimer and safety guidelines before flight. Refer to the quick start guide for more information on assembly and basic operation. Refer to the user manual for more comprehensive information.

## Video Tutorials

Go to the address below or scan the QR code to watch the tutorial videos, which demonstrate how to use the aircraft safely.



<https://www.dji.com/flycart-30/video>

## Downloading DJI Assistant 2 (Delivery Series)

Download DJI ASSISTANT™ 2 from: <https://www.dji.com/flycart-30/downloads>

- ⚠ • The operating temperature of this product is -20° to 45° C (-4° to 113° F). It does not meet the standard operating temperature for military-grade applications (-55° to 125° C (-67° to 257° F)), where the product is required to endure greater environmental variability. Only use the product for applications where the operating temperature range requirements are within those of the product grade.

# Contents

<b>Using This Manual</b>	<b>3</b>
Legends	3
Before Flight	3
Video Tutorials	3
Downloading DJI Assistant 2 (Delivery Series)	3
<b>General Information and System Description</b>	<b>8</b>
Introduction	8
Aircraft	8
Feature Highlights	8
Aircraft Overview	9
Flight Control Surfaces	10
Propulsion System	10
Avionics	10
Binocular Vision System and Active Phased Array Radars	10
Control Station	13
Remote Controller	13
DJI Pilot 2 App	27
Command and Control Link	38
Ground Operational Area Setup	38
Data Security	38
Low Battery and Low Voltage Warnings	39
RTK Functions	39
Enable/Disable RTK	39
Using with the DJI D-RTK 2 Mobile Station	40
Using with the Network RTK Service	40
Aircraft LEDs	41
Parachute	42
Propellers	42
<b>Performance and Limitations</b>	<b>44</b>
Performance	44
Prohibited Maneuvers	44

<b>Normal Procedures</b>	<b>45</b>
Airspace Environment	45
Flight Environment Requirements	45
Flight Recorder	45
Flight Restrictions and Unlocking	45
GEO (Geospatial Environment Online) System	45
GEO Zones	46
Flight Restrictions in GEO Zones	46
Unlocking GEO Zones	48
Maximum Altitude & Distance Restrictions	49
DJI AirSense	50
Radio Frequency Environment	51
Use of Launch and Recovery Equipment	51
Distance to Control Station	51
System Assembly	52
Preparing the Remote Controller	52
Preparing the Aircraft	54
Pre-Flight Checklist	57
System Starting (Basic Flight)	57
Calibrating the Compass	58
Takeoff/Landing	59
Takeoff	59
Landing	59
Cruise/Maneuvering Flight	60
Flight Modes	60
Return to Home	61
Alternate Landing	63
System Shutdown	65
Post-Flight Inspection	65
<b>Emergency Procedures</b>	<b>66</b>
Engine Failure	66
Fire	66
Loss of C2 Link	66

Loss of Navigation Systems	67
Control Station Failures	67
Flyaway	67
Reporting Requirements	67
<b>Intelligent Flight Battery</b>	<b>68</b>
Introduction	68
Battery Features	69
Using the Battery	70
Charging	70
Using Paired Batteries	70
Powering On/Off	70
Battery Hot Swapping	70
Single and Dual Battery Mode	71
Self-Heating	71
LED Patterns	74
Checking the Battery Level	74
LED Patterns During Charging	74
Battery Error LED Patterns	74
Other Statuses	75
Battery Storage	76
Transportation	77
Battery Maintenance	77
Battery Disposal	77
<b>Delivery</b>	<b>78</b>
Operation Requirements	78
Cargo Case Weight Calibration	78
Manual Operation	79
Flight Route Operation	80
<b>Updating Firmware</b>	<b>81</b>
Using DJI Pilot 2	81
Online Updating	81
Offline Updating	81
Using DJI Assistant 2 (Delivery Series)	81

<b>DJI DeliveryHub</b>	<b>83</b>
UI Features	83
Tasks	83
Admin	84
Statistics	85
Using DeliveryHub	85
Log In	85
Create Team	85
Binding the Team and the Aircraft	85
Create a Route	86
Perform Task	88
<b>Supplements</b>	<b>89</b>
Specifications	89
FAR Remote ID Compliance Information	94

# General Information and System Description

## Introduction

The DJI FLYCART™ 30 aircraft has a truss-style body and foldable arms. It is equipped with front and rear phased array radar systems, upward and downward binocular vision systems, an onboard parachute, an HD FPV camera, co-axial dual-prop motors, and a dual-battery system to ensure flight safety. The included Cargo Case has a maximum storage capacity of 70 L, large enough to meet everyday cargo transport needs. The Winch System (sold separately) enables aerial cargo loading and unloading for DJI FlyCart 30. It is suitable for use in challenging environments where the aircraft cannot land.

The DJI RC Plus remote controller has a built-in 7.02-inch high-bright screen that boasts a resolution of 1920×1200 pixels. It utilizes an Android operating system and has a variety of functions, such as GNSS, Wi-Fi, and Bluetooth. The built-in DJI PILOT™ 2 app and a wide range of function buttons make for easy operation. The remote controller has a maximum operating time of 3 hours and 18 minutes only using the internal battery, and up to 6 hours when using an external WB37 Intelligent Battery.

## Aircraft

### Feature Highlights

**Flight and Delivery Ability:** The max delivery payload is up to 30 kg when flying with two batteries and 40 kg when flying with a single battery. <sup>[1]</sup>

**Video Transmission:** The DJI RC Plus remote controller features O3 image transmission, and the max transmission distance is 20 km. <sup>[2]</sup>

**Safety and Protection:** The IP rating of the aircraft is IP55 and the aircraft body is anti-corrosion. The front and rear phased array radar systems and forward and downward binocular vision systems enable the aircraft to sense and avoid obstacles. The dual batteries system supports hot swapping and single battery mode. The onboard parachute can protect the aircraft and cargo in an emergency.

**Intelligent Delivery Mode and Management:** DJI FlyCart 30 supports cargo transportation by Cargo Case and Winch System. Auto delivery can be achieved through flight route planning. Dual remote controllers are able to control one aircraft. The DJI Pilot 2 app controls the aircraft easily and displays the real-time flight status. Flight route planning, flight task management, real-time monitoring, and data management can be done via DJI DeliveryHub.

[1] Tested at sea level.

[2] Tested in an open area with no electromagnetic interference. The remote controller is able to reach its maximum transmission distance of 20 km (12.43 mi) under FCC standard; Mainland China uses the SRRC standard and the maximum transmission distance is 8 km (4.97 mi). Pay attention to the prompts appearing in the DJI Pilot 2 app during flight.



## Aircraft Overview

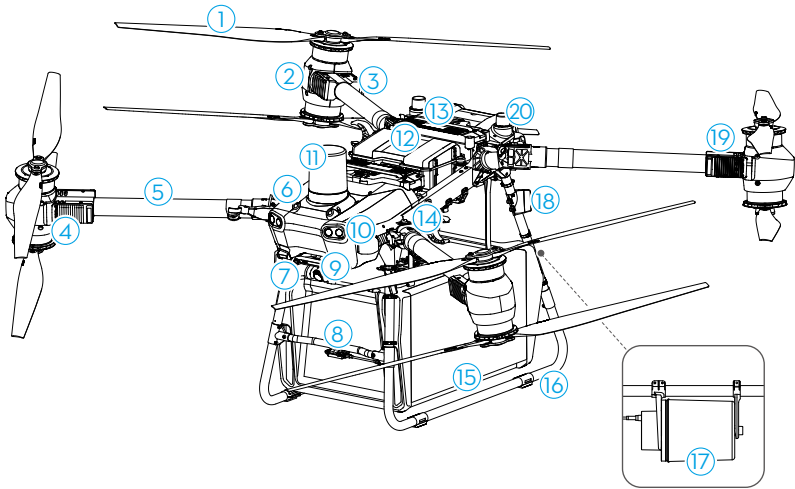

- |                                      |                                |
|--------------------------------------|--------------------------------|
| 1. Propellers                        | 11. Front Phased Array Radar   |
| 2. Motors                            | 12. Parachute                  |
| 3. Electronic Speed Controller (ESC) | 13. Intelligent Flight Battery |
| 4. Front LEDs                        | 14. Weight Sensors             |
| 5. Frame Arms                        | 15. Cargo Case                 |
| 6. Forward Binocular Vision System   | 16. Landing Gear               |
| 7. Downward Binocular Vision System  | 17. Rear Phased Array Radar    |
| 8. Reserved                          | 18. Video Transmitter Antennas |
| 9. FPV Gimbal Camera                 | 19. Rear LEDs                  |
| 10. Spotlights                       | 20. GNSS Antennas              |

## Flight Control Surfaces

Not applicable for multicopters.

## Propulsion System

The propulsion system consists of motors, ESCs, and folding propellers, to provide stable and powerful thrust.

## Avionics

The avionics includes an aerial-electronics system, image transmission system, binocular vision and radar system, cargo system, parachute, and FPV module.

## Flight Control and Navigation System

The flight control and navigation system built into the aircraft is integrated with modules such as the flight controller, IMU, barometer, GNSS receiver, RTK module, and compass, providing stable and reliable navigation and control. The dedicated industrial flight controller provides multiple flight modes and operation modes for various applications. The GNSS+RTK dual-redundancy system is compatible with GPS, GLONASS, BeiDou, QZSS, and Galileo. The aircraft also supports centimeter-level positioning when used with the built-in onboard D-RTK antennas. Dual-antenna technology provides strong resistance against magnetic interference.

## Communication Equipment

The aircraft boasts two OCUSYNC™ image transmission antennas and DJI O3 image transmission system, offering a maximum transmission range of 20 km for communication with the remote controller.

## FPV Module

The FlyCart 30 aircraft is equipped with an HD FPV gimbal camera. It helps the pilot to have better visibility of the flight environment and assists the aircraft in landing and releasing cargo precisely via the AR projection feature.

The tilt of the gimbal camera can be adjusted by using the left dial of the remote controller or the gimbal camera adjustment button in the DJI Pilot 2 app.

## Binocular Vision System and Active Phased Array Radars

The aircraft is equipped with a phased array radar system and binocular vision system.

The systems provide multi-directional obstacle sensing as well as bypass functions to ensure flight safety. In addition, the flight control system limits the descent speed of the aircraft according to the distance between the aircraft and the ground, as detected by the radar module. This helps the aircraft make smooth landings.

The max horizontal flight speed is limited to 15 m/s, while max ascent speed is limited to 5 m/s, and descent speed is limited to 3 m/s.

## Detection Range

Binocular vision system: 90° (horizontal), 180° (vertical), 0.5-29 m.

Forward phased array radar: 360° (horizontal), ±45° (vertical), ±45° (upward, cone), 1.5-50 m.

Rear phased array radar: 360° (vertical), ±45° (horizontal), 1.5-200 m.

- 
- ⚠ • The aircraft cannot sense obstacles that are not within the detection range. Fly with caution.
  - The effective detection range varies depending on the size and material of the obstacle. When sensing objects such as buildings that have a radar cross section (RCS) of more than -5 dBsm, the effective detection range is 50 m. When sensing objects such as power lines that have an RCS of -10 dBsm, the effective detection range is approximately 30 m. When sensing objects such as dry tree branches that have an RCS of -15 dBsm, the effective detection range is approximately 20 m. Obstacle sensing may be affected or unavailable in areas outside of the effective detection distance.
  - Fly with caution when the aircraft is near an obstacle that is at a similar altitude as the bottom of the aircraft. The aircraft will not be able to detect the obstacle as most or even the whole obstacle is out of the detection range.
- 

## Horizontal Obstacle Avoidance Function

Enable the function in DJI Pilot 2.

Obstacle avoidance is used in the following two scenarios:

1. The aircraft begins to decelerate and hovers in place when it detects an obstacle and the distance is less than the safety distance that corresponds to the current flight speed. While decelerating, users cannot control the aircraft. The aircraft enters obstacle avoidance mode after hovering in place. Users can fly in a direction away from the obstacle to regain full control of the aircraft.
2. The aircraft begins to decelerate and hovers in place when it detects an obstacle and the distance is further than the safety distance that corresponds to the current flight speed. While decelerating, the user cannot accelerate in the direction of the obstacle, but can fly in a direction away from the obstacle.

- 
- ⚠ • Obstacle avoidance is disabled during auto landing. Make sure to operate the aircraft with caution when controlling the aircraft manually during auto landing.
  - In some scenarios, such as with power lines, small obstacles, or objects that are at the same level as the landing gear, obstacle sensing may be rendered ineffective. Fly with caution.
- 



## Vertical Obstacle Avoidance Function

Enable the function in DJI Pilot 2. The aircraft begins to decelerate and hovers in place when it detects an obstacle via vertical obstacle sensing. When the aircraft is braking or hovering, users cannot accelerate in the direction of the obstacle, but can fly in a direction away from the obstacle.

- 
- ⚠ • Downward obstacle sensing is unavailable when using the winch system.
-

## Radar Usage Notice

---

-  • DO NOT touch or let your hands or body come in contact with the metal parts of the radar module when powering on or immediately after flight as they may be hot.
  - Maintain full control of the aircraft at all times and do not rely completely on the radar module and DJI Pilot 2 app. Keep the aircraft within VLOS at all times. Use your discretion to operate the aircraft manually to avoid obstacles.
  - In manual flight, pay attention to the flying speed and direction when operating. Be aware of the surrounding environment and avoid the blind spots of the radar module.
  - The obstacle avoidance functions are disabled in Attitude mode.
  - Flying on a rainy day may cause the radar to misjudge obstacles, and it is recommended to disable the obstacle avoidance function in this case.
  - When sensing objects such as diagonal stay wires, tilted telephone poles, and wires that are at an angle to the flight direction of the aircraft, radar detection performance will be affected since most of the radar electromagnetic waves are reflected to other directions. Fly with caution.
  - When flying above trees that are closely grouped together, the radar cannot recognize the difference between dense tree cover and the ground. Fly with caution.
  - Operate with extra caution when flying over inclined surfaces. The recommended maximum inclination at different aircraft speeds are 10° at 1 m/s, 6° at 3 m/s, and 3° at 5 m/s.
  - Comply with local radio transmission laws and regulations.
  - The sensitivity of the radar module may be reduced when operating several aircraft within a close distance. Operate with caution.
  - The radar module is a precision instrument. DO NOT squeeze, tap, or hit the radar module.
  - Before use, make sure that the radar module is clean and the outer protective cover is not cracked, chipped, sunken, or misshapen.
- 
-  • Keep the protective cover of the radar module clean. Clean the surface with a soft, damp cloth and air dry before using again.
- 

## Binocular Vision System Usage Notice

---

-  • The performance of the binocular vision system is affected by light intensity and the patterns or texture of the surface being flown over. Operate the aircraft with great caution in the following situations:
  - a. Flying near monochrome surfaces (e.g., pure black, pure white, pure green).
  - b. Flying near highly reflective surfaces.
  - c. Flying near water or transparent surfaces.
  - d. Flying in an area where the lighting changes frequently or drastically.
  - e. Flying near extremely dark (< 10 lux) or bright (> 10,000 lux) surfaces.
  - f. Flying near surfaces with repeating identical patterns or textures or with particularly sparse patterns or textures.

- Keep the cameras of the binocular vision system clean at all times.
- Make sure that there are clear patterns and adequate lighting in the surroundings since the binocular vision system relies on images of the surrounding environment to obtain displacement data.
- The obstacle sensing function of the binocular vision system may not work properly when the aircraft is operated in a dimly lit environment or over water or surfaces without a clear pattern.



- Keep the cameras of the binocular vision system clean at all times. Make sure that the aircraft is powered off. First remove any larger pieces of grit or sand then wipe the lens with a clean, soft cloth to remove dust or other dirt.

## Control Station

### Remote Controller

#### Remote Controller Overview

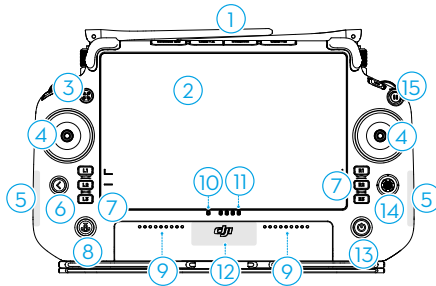

- External Antennas**  
Relays aircraft control and image transmission signals.
- Touchscreen**  
Displays system and app views, while supporting up to 10 touch points. Make sure the touchscreen is clean and completely dry before use. Otherwise, viewing and touch effects may be affected.
- Aircraft Authority Button**  
Used to take control of the aircraft and indicate the aircraft control status. Press once to obtain aircraft control, press and hold to lock aircraft control, and press once again to unlock aircraft control. Refer to Guide on the home screen for more information.
- Control Sticks**  
Controls aircraft movement. Control mode can be set in DJI Pilot 2.
- Internal Wi-Fi Antennas**  
DO NOT block the internal Wi-Fi antennas during use, otherwise the signals may be affected.
- Back Button**  
Press once to return to the previous screen. Press twice to return to the

home screen. Hold the back button and then press another button to activate button combinations. Refer to the Button Combinations section for more information.

7. L1/L2/L3/R1/R2/R3 Buttons

When buttons are displayed in the app near these physical buttons or the prompts in the app include L1/L2/L3/R1/R2/R3, press the corresponding button on the remote controller to operate instead of tapping the touchscreen.

8. Return to Home (RTH) Button

Press and hold to initiate RTH. Press again to cancel RTH.

9. Microphones

10. Status LEDs

Indicates the status of the remote controller. Refer to Guide on the home screen for more information.

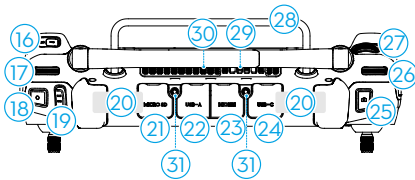

16. C3 Button

Customize the function of this button in DJI Pilot 2.

17. Left Dial

Controls the tilt of the FPV gimbal camera.

18. Reserved Button

19. Flight Mode Switch

The three positions of the switch

11. Battery Level LEDs

Displays the current battery level of the internal battery.

12. Internal GNSS Antennas

DO NOT block the internal GNSS antennas during use, otherwise the positioning accuracy may be affected.

13. Power Button

Press once to check the current battery level. Press, and then press and hold to power the remote controller on or off. While the remote controller is powered on, press once to turn the touchscreen on or off.

14. 5D Button

The functions of this button can be set in DJI Pilot 2.

15. Flight Pause Button

Press once to have the aircraft brake and hover in place (only when GNSS or vision systems are available).

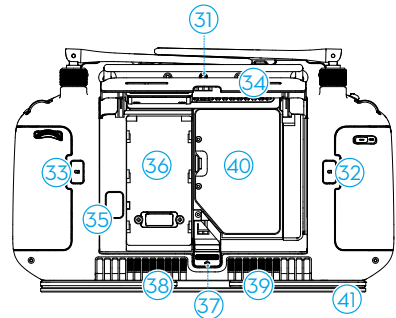

correspond to: N-mode (Normal), S-mode (Sport), and F-mode (Winch System).

20. Internal Antennas

Relays aircraft control and image transmission signals. Do not block the internal RC antennas during use. Otherwise, the signals may be affected.

21. microSD Card Slot

For inserting a microSD card.

22. USB-A Port
23. HDMI Port
24. USB-C Port
 

For charging the remote controller or connecting to a computer. After connecting to a computer, users can update firmware and export logs via the DJI Assistant 2 software.
25. Reserved Button
26. Right Dial
 

For reeling down/up the winch cable. (winch system sold separately)
27. Scroll Wheel (reserved)
28. Handle
29. Speaker
30. Air Vent
 

For heat dissipation. DO NOT block the air vent during use.
31. Mounting Hole (reserved)
32. C1 Button
 

Customize the function of the button in DJI Pilot 2.
33. C2 Button
 

Customize the function of the button in DJI Pilot 2.
34. Rear Cover
35. Battery Release Button
36. Battery Compartment
 

For the WB37 Intelligent Battery.
37. Rear Cover Release Button
38. Alarm
39. Air Intake
 

For heat dissipation. DO NOT block the air intake during use.
40. Dongle Compartment
41. Bracket

## Using the Remote Controller

### Powering On/Off

Press the power button once, then press and hold to power on the remote controller.

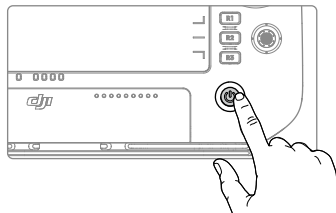

## Installing the WB37 Intelligent Battery

Push the rear cover release button to open the rear cover. Insert the WB37 battery into the battery compartment and push forward until it clicks firmly in place. To remove the WB37 battery, press and hold the battery release button and push the battery downward.

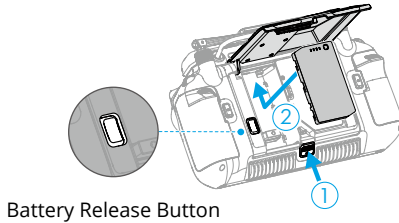

## Charging

Use the DJI 100W USB-C Power Adapter to charge both the internal and external batteries simultaneously.

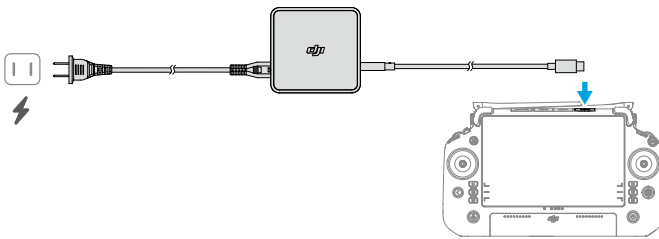

## Charging Mechanism

1. When the remote controller is connected with both a charging device and an external battery, the remote controller will be powered by the charging device.
2. When the external battery has been inserted and the remote controller is not connected to a charging device, the remote controller will be powered by the external battery. When the external battery is depleted, the remote controller will be powered by the internal battery.

- 
- ⚠** • Use the provided charger to charge the remote controller. Otherwise, use a locally certified USB-C charger with a maximum rated power and voltage of 65 W and 20 V.
- Fully charge and discharge the internal and external batteries of the remote controller at least once every three months. The battery will deplete when it is stored for an extended period.
-



## Operating the Aircraft

There are three pre-programmed modes in DJI Pilot 2. The modes are Mode 1, Mode 2, and Mode 3. Control Stick Mode can be set in DJI Pilot 2. Tap **•••** > **🛩️** > Control Stick Mode or go to Preflight Check > Control Stick Mode to set.

### Mode 1

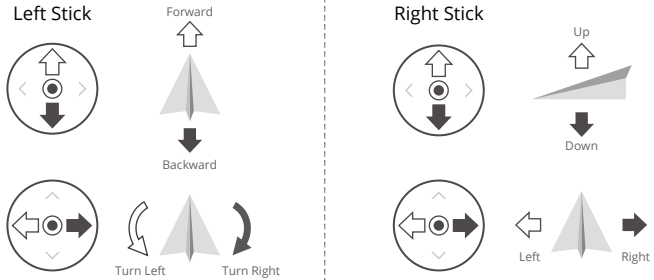

### Mode 2

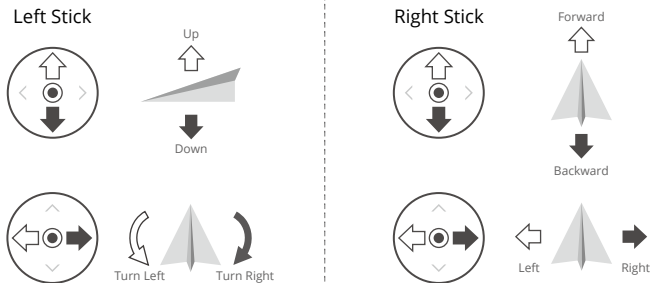



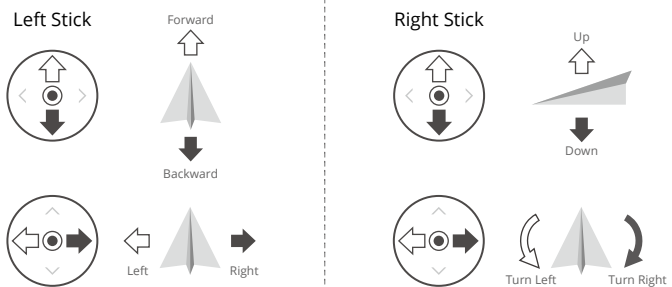





### Mode 3



This manual uses Mode 2 as an example to describe control stick operation.

- ☀️ • Stick Neutral/Center Point: Control sticks are in the center.
- Moving the control stick: The control stick is pushed away from the center position.

Remote Controller (Mode 2)	Aircraft	Remarks
		<p>Moving the left stick up or down changes the aircraft's altitude.</p> <p>Push the stick up to ascend and down to descend. The more the stick is pushed away from the center position, the faster the aircraft will change altitude. Push the stick gently to prevent sudden and unexpected changes in altitude.</p>
		<p>Moving the left stick to the left or right controls the orientation of the aircraft.</p> <p>Push the stick left to rotate the aircraft counter-clockwise and right to rotate the aircraft clockwise. The more the stick is pushed away from the center position, the faster the aircraft will rotate.</p>
		<p>Moving the right stick up and down changes the aircraft's pitch.</p> <p>Push the stick up to fly forward and down to fly backward. The more the stick is pushed away from the center position, the faster the aircraft will move.</p>
		<p>Moving the right stick to the left or right changes the aircraft's roll.</p> <p>Push the stick left to fly left and right to fly right. The more the stick is pushed away from the center position, the faster the aircraft will move.</p>

- ⚠ • Keep the remote controller away from magnetic materials such as magnets and loudspeakers to avoid magnetic interference.
- To avoid damage to the control sticks, it is recommended that the remote controller be stored in the carrying case when being carried or transported.

### Flight Mode Switch

Toggle the switch to select the desired flight mode.

Position	Flight Mode
F	F-mode (Winch System)
S	S-mode (Sport)
N	N-mode (Normal)

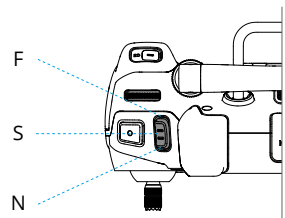

F-mode is set for use with the winch system by default, but it can be set to A-mode. Go to Camera View of the DJI Pilot 2 and tap **•••** >  > Flight Modes > ASN to set to A-mode.

## Return to Home (RTH) Button

Press and hold the RTH button until the remote controller beeps to start RTH. The aircraft will fly to the last updated Home Point. Users can control aircraft altitude and speed while it flies to the Home Point. Press this button again to cancel RTH and regain control of the aircraft.

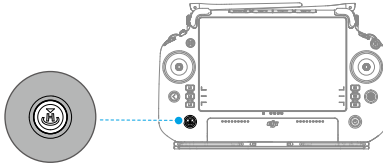



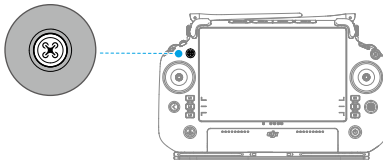

## Aircraft Authority Button

Press once to obtain aircraft control, press and hold the button to lock the aircraft control.



Refer to the table for the different statuses that correspond to different LED blinking patterns.

	Solid red	Aircraft not connected
	Solid green	Connected to and controlling aircraft
	Solid white	Not controlling aircraft
	Solid blue	Aircraft control locked by current user

## L1/L2/L3/R1/R2/R3 Buttons

Find the descriptions of these button functions next to the L1/L2/L3/R1/R2/R3 buttons in DJI Pilot 2.

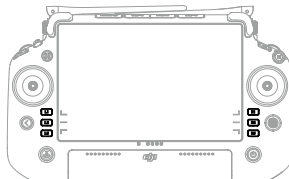

## Button Customization and Combinations

### Customizable Buttons

The C1, C2, C3, and 5D buttons are customizable. Open DJI Pilot 2 and enter camera view. Tap **...** and tap  to configure the functions of these buttons. In addition, combinations can be customized using the C1, C2, and C3 buttons with the 5D button.

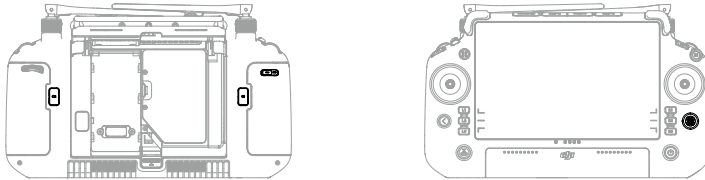

### Button Combinations





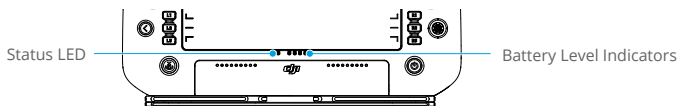

Some frequently used features can be activated by using button combinations. To use button combinations, hold the back button and operate the other button in the combination.

Button Combinations	Descriptions
Back Button + Left Dial	Adjust Brightness
Back Button + Right Dial	Adjust Volume
Back Button + Record Button	Record Screen
Back Button + Shutter Button	Screenshot
Back Button + 5D Button	Toggle up - Home; Toggle down - Shortcut settings; Toggle left - Recently opened apps

































## Remote Controller LEDs



The status LED displays the linking status.

Blinking Patterns	Descriptions
 —	Solid Red Disconnected from the aircraft
 ·····	Blinks red Aircraft low battery level
 —	Solid green Connected with the aircraft
 ·····	Blinks blue The remote controller is linking to an aircraft
 —	Solid yellow Firmware update failed
 ·····	Blinks yellow Remote controller low battery level
 ·····	Blinks cyan Control sticks not centered

The battery level indicators display the battery level of the controller.

Blinking Patterns				Battery Level
				88%~100%
				75%~87%
				63%~74%
				50%~62%
				38%~49%
				25%~37%
				13%~24%
				0%~12%

## Remote Controller Alert

The remote controller vibrates or beeps twice to indicate an error or warning. For detailed information, see the real-time prompts on the touchscreen or in the DJI Pilot 2 app. To disable some alerts, slide down from the top and select Do Not Disturb in Quick Settings.

Any voice prompts and alerts will be disabled in Silent mode, including alerts during RTH and low battery alerts for the remote controller or aircraft. Fly with caution.

## Linking the Remote Controller

The remote controller is linked to the aircraft by default. Linking is only required when using a new remote controller for the first time.

1. Power on the remote controller and the aircraft, then launch DJI Pilot 2.
2. Tap Link to Aircraft to link. The status LED of the remote controller will blink blue, and the remote controller will beep during linking.
3. Press and hold the power button on the aircraft for at least five seconds. The aircraft power indicator will blink to indicate linking has started.
4. The Status LED on the remote controller glows solid green if linking is successful. If linking fails, enter linking status again and retry.

## Image Transmission

The remote controller features O3 technology, which enables triple-channel 1080p Image transmission and supports Single Operator or Dual Operator mode.

1. When in Single Operator mode, the remote controller supports dual-channel 1080p Image transmission.
2. When in Dual Operator mode, the remote controller supports triple-channel 1080p Image transmission and allows seamless swapping between input feeds.

## Optimal Transmission Zone

Unfold and adjust the antennas. The strength of the remote controller signal is affected by the position of the antennas. Adjust the direction of the external RC antennas of the remote controller so that the controller and aircraft are within the optimal transmission zone.

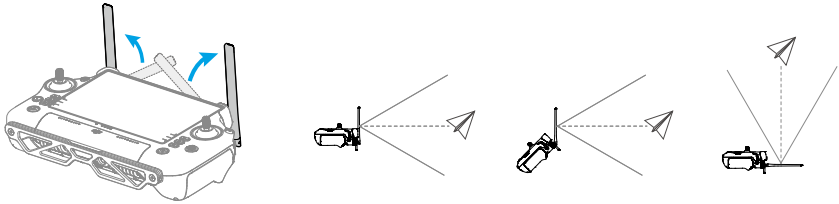

- 
- ⚠ • DO NOT overstretch the antennas to avoid damage. Contact DJI Support to repair the remote controller if the antennas are damaged. A damaged antenna will greatly decrease the performance of the remote controller and might affect flight safety.
  - During flight, DO NOT use other 2.4 GHz or 5.8 GHz communication devices in the same frequency band at the same time, so as not to interfere with the communication signal of the remote controller. For example, avoid enabling mobile phone Wi-Fi.
  - A prompt will be displayed in DJI Pilot 2 if the transmission signal is weak during flight. Adjust the antennas to make sure that the aircraft is in the optimal transmission range.
-

# Operating the Touchscreen

## Home



The top bar displays the time, network status, as well as battery levels of the internal and external batteries of the remote controller.

## Screen Gestures

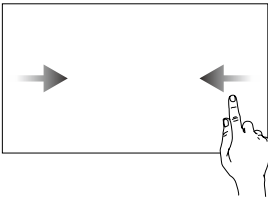

Slide from the left or right to the center of the screen to return to the previous screen.

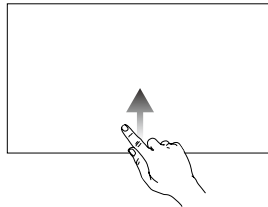

Slide up from the bottom of the screen to return to the home screen.

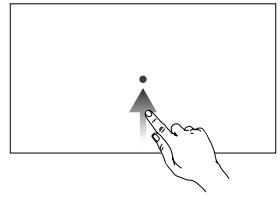

Slide up from the bottom of the screen and hold to access recently opened apps.

## Quick Settings

Slide down from the top to enter Quick Settings.

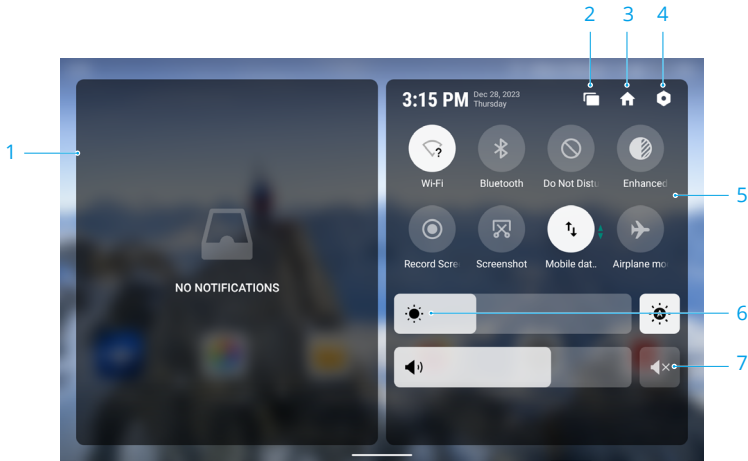

### 1. Notifications

Tap to view system or app notifications.

### 2. Recent

Tap to view and switch to recently opened apps.

### 3. Home

Tap to return to the home screen.

### 4. System Settings

Tap to access system settings.

### 5. Shortcuts

- Tap to enable or disable Wi-Fi. Hold to enter settings and connect to or add a Wi-Fi network.
- Tap to enable or disable Bluetooth. Tap and hold to open settings and connect with nearby Bluetooth devices.
- Tap to enable DO NOT Disturb mode. In this mode, system prompts will be disabled.

Display enhancement. Once enabled, the display brightness is enhanced.

Tap to start screen recording.

Tap to screenshot the screen.

Mobile data. Tap to turn mobile data on or off; long press to set mobile data and diagnose network connection status.

Tap to enable Airplane mode. Wi-Fi, Bluetooth, and mobile data will be disabled.

### 6. Adjust Brightness

Slide the bar to adjust the brightness. Tap the icon to auto-brightness mode. Tap the icon or slide the bar to switch to manual brightness mode.

### 7. Adjust Volume

Slide the bar to adjust the volume and tap to mute.



## Advanced Features

### Calibrating the Compass

The compass may need to be calibrated after the remote controller is used in areas with electromagnetic interference. A warning prompt will appear if the compass of the remote controller requires calibration. Tap the warning prompt to start calibrating. In other cases, follow the steps below to calibrate your remote controller.

1. Power on the remote controller and enter the home page.
2. Select System Settings, scroll down, and tap Compass.
3. Follow the on-screen instructions to calibrate the compass.
4. A prompt will be displayed when the calibration is successful.

### HDMI Settings

The touchscreen can be shared with a display screen via an HDMI cable. The resolution can be set by entering Settings, Display, and then Advanced HDMI.

### Dual Operator Mode

FlyCart 30 aircraft supports Dual Operator mode that allows two pilots to operate an aircraft simultaneously using remote controllers A and B. In this mode, both remote controllers can have equal control of the aircraft. The remote controller that has aircraft control can control all aircraft operations, while the other remote controller has no control over the operation of the aircraft and will only display a live view of operation.

#### Setting the Dual Operator Mode

Before using Dual Operator mode, the pilot needs to link the aircraft with both remote controller A and remote controller B. Follow the steps below to link the remote controllers.

1. Run the DJI Pilot 2 app.
2. Enter the homepage and tap Remote Controller A/B to activate linking. During linking, the status LED of the remote controller blinks blue and the remote controller beeps. Press and hold the power button on the aircraft for at least five seconds. The aircraft power indicator will blink and beep twice to indicate that linking has started. When linking is successful, the aircraft status indicators will blink green, the remote controller will beep twice, and the remote controller status LED turn solid green.
3. Thereafter, the aircraft authority button on the remote controller with control of the aircraft will turn green, and the aircraft authority button of the other remote controller will turn white.



• Link the two remote controllers one by one. Make sure to link remote controller A with the aircraft first, and then link remote controller B.

---

### Using Dual Operator Mode

1. Make sure both remote controllers are linked and connected with the aircraft before using Dual Operator mode. Remote controller A has aircraft control by default, and the user using remote controller B can only view.
2. Either pilot can take over control of a device as needed. Press once on the aircraft authority button on the remote controller to obtain aircraft control. To lock the aircraft control, press and hold the aircraft authority button. The aircraft authority button turns to blue after the aircraft control is locked.

3. In Dual Operator mode, a control transfer mechanism will be triggered if one of the remote controllers is disconnected from the aircraft. If the disconnected remote controller has aircraft control, the other remote controller will receive a notification that the user may manually take over aircraft control. If the pilot of the connected remote controller chooses not to take over aircraft control, the aircraft will automatically perform the signal lost action. If the pilot of the connected remote controller does not choose either option within a specified time period, the aircraft will also perform the signal lost action.
4. If the disconnected remote controller reconnects with the aircraft during the flight, it will not resume its previous control when the aircraft is controlled by the other remote controller. The pilot may gain control of the device again as needed. It will resume its previous control if the aircraft is not controlled by another remote controller.
5. Remote controller A can be used to update the firmware of the aircraft when connected with the aircraft, but remote controller B can only be used to update the firmware of remote controller B.
6. Uploading Logs Using DJI Pilot 2: Users can upload the logs of both the aircraft and remote controller through the remote controller that has aircraft control, and can only upload the logs of the remote controller that has no aircraft control.
7. The user of remote controller B cannot adjust settings for network RTK or custom network RTK.
8. Remote controller B cannot be used to update the GEO Zone database.
9. Remote controller B cannot be used to open Unlocking Licenses.

## IP Rating

The DJI RC Plus remote controller has been tested in a lab environment and rated IP54 in accordance with the global IEC 60529 standard. The protection rating is not permanent and may lower over an extended period.



- DO NOT use the remote controller when the precipitation exceeds 50 mm in 24 hours.
  - DO NOT open any cover in the rain, including the external port cover, remote controller rear cover, dongle compartment cover, or air vent and air intake covers. DO NOT mount or remove control sticks or antennas in the rain. Before opening any cover or removing the control sticks or antennas, move the remote controller indoors and make sure it is clean and completely dry.
  - When using the remote controller in the rain, make sure all covers are attached firmly and control sticks are screwed in place securely.
  - It is normal to have water stains around the port when opening the port cover after use. Wipe off water stains before using the external port.
  - The product warranty does not cover water damage.
- 

The aircraft does not achieve an IP54 protection rating in the following circumstances:

- a. The cover of the external port is not attached firmly.
- b. The remote controller rear cover is not attached firmly.
- c. The air vent and air intake covers are not installed firmly.
- d. The dongle compartment cover is not attached firmly.

- e. The control sticks are not screwed in place securely.
- f. Antennas are not screwed in place securely.
- g. The remote controller has suffered other damage such as a cracked shell or compromised waterproof adhesive.

## DJI Pilot 2 App

The DJI Pilot 2 app integrates real-time video transmission, flight route settings, aircraft settings operation features, and more.

### Home

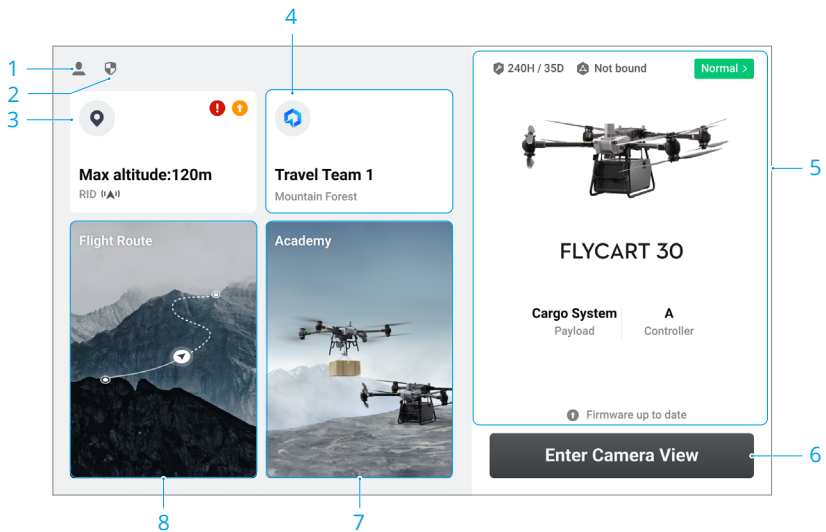

#### 1. Me

Tap to view flight records, download offline maps, manage GEO Zone unlocking, read help documentation, select a language, and view app information.

#### 2. Data and Privacy

Tap to manage network security modes, set security codes, manage app cache, and clear DJI device logs.

#### 3. GEO Zone Map

Tap to view the GEO Zone Map, where users can check even when offline whether the current operating area is in a restricted zone or authorization zone. Users can also view the current flyable altitude of different areas.

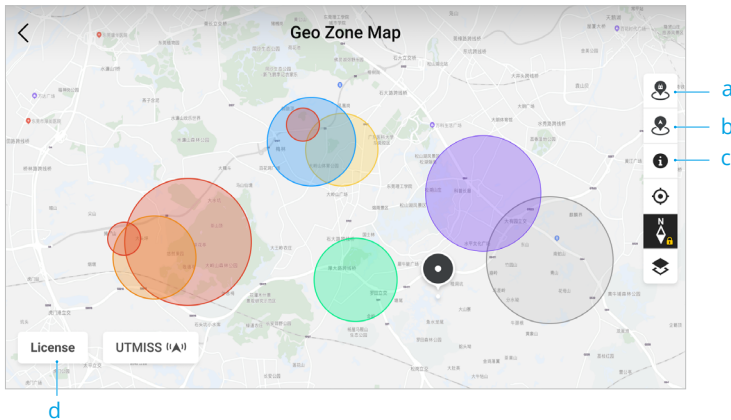

- a. Tap to update the GEO Zone database of the remote controller, if an update is available.
- b. Tap to update the GEO Zone database of the aircraft, if an update is available.
- c. Tap to set display different GEO Zones.
- d. Tap to enter and manage unlocking certificates. If the aircraft is already connected to the remote controller, users can select an unlocking certificate directly to unlock a GEO Zone.

#### 4. Cloud Service

Tap to enter the cloud service page, where users can view the connection status of the cloud service, or select the DJI DeliveryHub or Customize Livestream.

- a. The name of the team currently logged in can be set. Tap the DJI DeliveryHub icon to change team.
- b. Livestream URL and status will be displayed if RTMP or RTSP is connected.

#### 5. Device Status

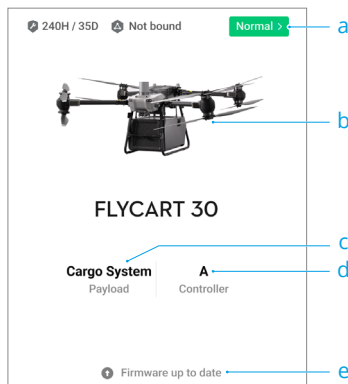

- a. Displays the status of the aircraft, remote controller, and payload. The health status of the aircraft and the remote controller is displayed here. If it appears in green (normal), the aircraft is functioning normally and can take off. If it appears in orange (caution) or

red (warning), the aircraft is not functioning normally and must be checked and cleared before takeoff. Read the Health Management System (HMS) section for more details. Tap to enter the Health Management System.

- If the current remote controller is not connected to the aircraft, a picture of the remote controller will be displayed. Tap to link the remote controller to the aircraft, and the aircraft model and picture will be displayed after it is connected.
- Display Cargo System or Winch System.
- The current remote controller role is displayed as A or B (the role name of the current remote controller appears in black). Tap to view the error information on the remote controller or switch the remote controller role.
- Firmware information. A prompt will appear notifying the user that new firmware is available. Tap to start updating.

## 6. Camera View

Tap to enter preflight check view and camera view.

## 7. Academy

Tap to view product tutorials, flight guides, industry cases, and download product manuals to the remote controller.

## 8. Flight Route

Tap to enter the flight route library. Users can create and view flight routes. Tap to view all the favorite flight routes in Favorites. Flight routes can be imported from and exported in batches to the remote controller or another external mobile storage device. If DJI DeliveryHub is connected, you can also view all flight routes sent from the cloud or upload local tasks to the cloud. Refer to the Flight Route section for details.

# Preflight Check View

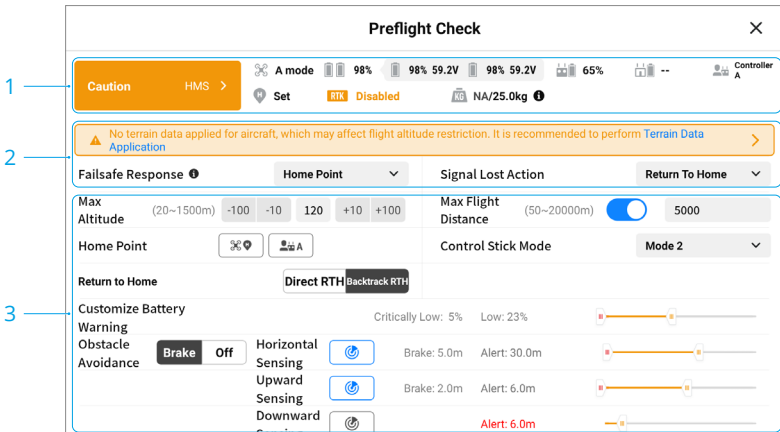

- View the aircraft's health information, flight mode, Intelligent Flight Battery level, remote controller role, remote controller internal and external battery levels, Home Point status and RTK status.

2. Displays system notifications, including aircraft basic information, weather, frame arm lock status, payload weight, etc.
3. Check and set the following parameters.

RTH Altitude	The flight altitude at which the aircraft returns to home.
Signal Lost Action	The action the aircraft will take when the remote controller signal is lost. Can be set to Hover, Descend, RTH, Alternate Site.
Max Altitude	The max flight altitude of the aircraft.
Max Flight Distance	The max flight distance the aircraft can reach.
Home Point	Home Point can be set to aircraft position or remote controller position.
Failsafe Response	The action the aircraft will take if the aircraft is functioning abnormally.
Control Stick Mode	Mode 1, Mode 2, or Mode 3 can be selected.
Propeller Type	Select the propeller type mounted on the aircraft.
Customize Battery Warning	The low battery warning will appear when the battery level reaches the set value.
Obstacle Avoidance	The aircraft will brake and hover in place when an obstacle is detected if set to Brake. Brake Distance and Warning Distance can be set separately.

- ☀ It is recommended to carefully conduct the preflight check according to the operation scenario and requirements before takeoff.
- Before performing a flight route, conduct a preflight check and verify the basic parameter information of the flight route. Refer to the flight route section for details.

## Camera View

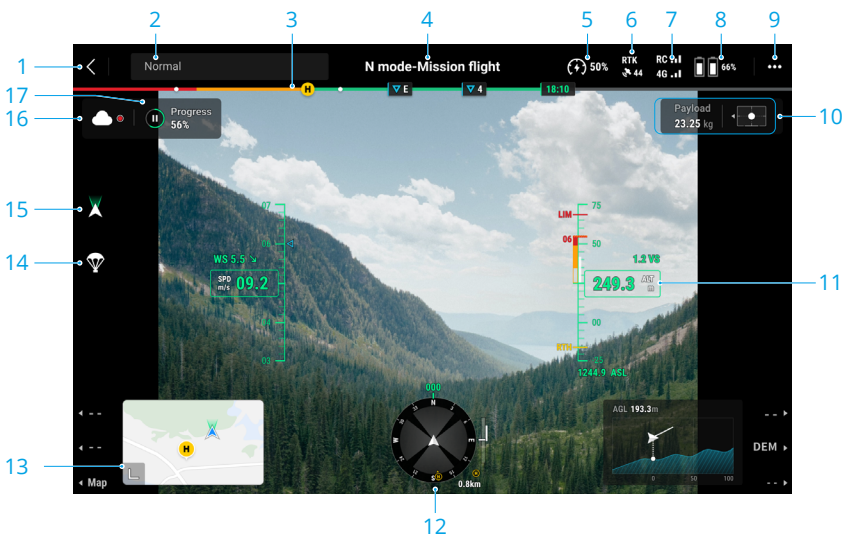

## 1. Back

Tap to return to the homepage of the DJI Pilot 2 app.

## 2. System Status Bar

Displays aircraft flight status and various warning messages. If a new alert appears during flight, it will also be displayed here and continue flashing. Tap to view the information and stop the flashing.

## 3. Intelligent Flight Battery Level Indicator

The battery level indicator bar provides a dynamic display of the remaining power of the current Intelligent Flight Battery and the flying time. Each battery state is indicated by a different color. Refer to the table below for details.

Green	Indicates the battery power is sufficient for flight.
Yellow	Indicates the battery level is low and it is recommended to fly in the area near the user.
Red	Indicates the battery level is critically low. The user should land the aircraft as soon as possible and replace the batteries.
White dots	Threshold that a user can set for low battery warning and critical low battery warning.
H	The recommended RTH battery level. The remote controller will remind the user that the current battery level is only sufficient for RTH.
E	The evaluated battery level. Indicates the battery level required when flying to the end of the flight route or alternate site or Home Point when performing a flight route.

## 4. Flight Status

Display the flight mode and flight status. Tap to enter Preflight Check view.

## 5. Propulsion System Status

Displays the propulsion system data and status. Pay attention to the value of the propulsion system. Return to home and land as soon as possible to check the propulsion system status if there is a warning.

## 6. RTK and GNSS Positioning Status

Displays the RTK status and the number of GNSS satellites. When the aircraft RTK module is enabled, the RTK icon will turn white; when it is disabled, the RTK icon will turn gray; when there is no signal, the RTK icon will turn red. Tap the status icon to enable/disable RTK, and view the status of the RTK mode and GNSS positioning. When the GNSS signal is strong and the number of GNSS satellites is 15 or above, it will indicate it is safe to take off.

## 7. Signal Strength

Includes HD video link quality and remote controller link quality. The icon in white indicates a strong signal; the icon in yellow indicates medium signal strength; the icon in red indicates poor signal strength. If the signal is lost, the icon will display a disconnected status in red. If DJI Cellular module is installed, the enhanced transmission signal will be displayed.

## 8. Intelligent Flight Battery Level

Displays the remaining battery level of the aircraft. Tap to view battery level, voltage, and temperature information. The battery level unit can be selected as time or distance.

## 9. Settings

Tap to expand the settings menu to set the parameters.

### Flight Controller Settings

Home Point Settings	Home Point can be set to aircraft position or remote controller position.
RTH Altitude	The flight altitude when the aircraft returns to home. When the aircraft is farther than 50 m from Home Point, the aircraft will automatically calculate RTH route, fly to an open area, ascend to preset altitude, and return to home. When the aircraft is 5 to 50 m from the Home Point, the aircraft will fly the planned route and return to home at current altitude. When the aircraft is less than 5 m from Home Point, the aircraft will land automatically.
Max Altitude	The max flight altitude of the aircraft.
Distance Limit	The max flight distance of the aircraft will be limited when enabled.
Max Flight Distance	The max flight distance of the aircraft.
Sensor Status	Tap to view IMU and Compass status and start the corresponding calibrations.
Signal Lost Action	The aircraft action can be set to Hover, Land, RTH, Alternate Site when the remote controller signal is lost.
Coordinated Turn	Improves aerodynamic efficiency. The front of the aircraft will follow the direction of the turn without side slipping (only available in manual flight).
GNSS	GPS+Galileo+Beidou or only Beidou can be selected.

### Obstacle Sensing Settings

Obstacle Avoidance can be set to brake or turned off.

**Brake:** The aircraft will automatically brake after detecting obstacles.

**Off:** The aircraft will not automatically bypass obstacles or brake, but alerts will still appear for detected obstacles. Fly with caution.

Horizontal and vertical warning distance can be set separately. The indicator will display a yellow shaded area if obstacles are within the preset warning distance but the aircraft will not brake.

### Remote Controller Settings

Remote Controller Channel	Select a channel for linking the remote controller and the aircraft.
Control Stick Mode	Can be set to Mode 1, Mode 2 or Mode 3.
Remote Controller Calibration	Control sticks and dial can be calibrated to increase sensitivity.
Customize RC Buttons	C1, C2, C3, and 5D buttons can be customized, and the button combinations can also be customized.
Link to Aircraft	Tap to link the remote controller to the aircraft.

### Image Transmission Settings

Includes enhanced transmission settings, work frequency, channel mode, video output type, output display, and show flight parameters.



### Aircraft Battery

Includes battery hot swapping switch, hot swapping timeout duration, safe flight assistance, and functions to customize battery warning.

### Payload

The payload page will display different information according to whether the cargo system or the winch system is in use. Cargo system page includes weight sensor calibration and resetting. Winch system settings include swing control settings, winch system type, cargo release settings, and calibration.

### FPV Gimbal Settings

Includes gimbal tilt limit extension, gimbal tilt smooth start/stop, max gimbal tilt speed, option to reset gimbal parameters, gimbal calibration, and gimbal adjustment options.

### RTK Module

Include RTK positioning, maintain positioning accuracy mode, and select RTK service type.

### •••General

Includes show AGL near ground, show projected AR point, map switch, show flight trajectory, show GPS, unit settings, LED settings, ESC beeping, device name, and Flysafe database.

Once enabling show projected AR point, the AR projection will point to the selected area to assist in releasing cargo by adjusting the FPV gimbal downward.

## 10. Weight and Center of Gravity Detection

Displays the cargo weight and center of gravity position. DO NOT exceed payload capacity. If the center of gravity icon is red, indicates the center of gravity of the cargo needs to be adjusted until the icon turns white.

## 11. Primary Flight Display (PFD)

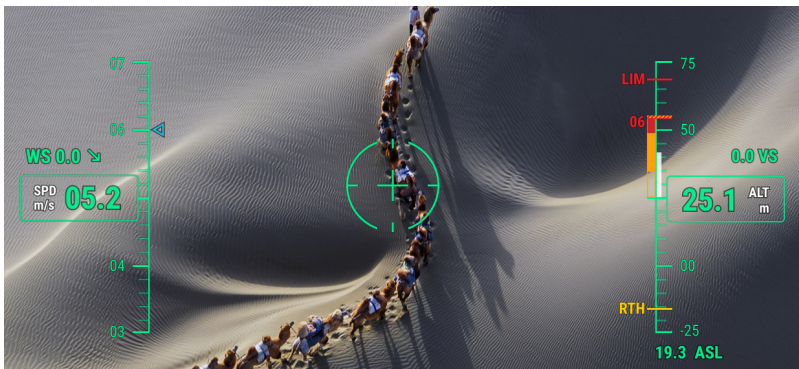

WS: Wind speed and direction. The wind direction is relative to the aircraft.

SPD: Aircraft horizontal speed.

VS: Aircraft vertical speed.

ALT: The altitude of the aircraft relative to the takeoff point.

LIM: Altitude limit configured by the user.

RTH: The RTH altitude set by the user.

ASL: The absolute altitude of the aircraft.

## 12. HSI Navigation Display

Shows the aircraft and gimbal orientation, as well as obstacle avoidance information from a horizontal perspective.

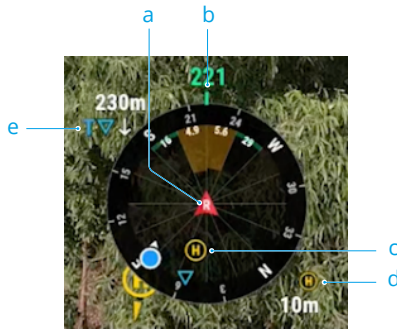

- a. Aircraft Navigation: Display rotates with the aircraft. The white line drawn by the aircraft indicates the flight direction and speed of the aircraft.
- b. Aircraft Orientation: Displays the current orientation of the aircraft. The displayed degree is counted clockwise from the north, with the north assumed as 0 degrees and the step length being 30 degrees. For example, the number 24 in the compass indicates the heading of the aircraft after a 240-degree clockwise rotation from 0 degrees.
- c. Home Point and Remote Controller Orientations:
  - i. Displays the home position relative to the aircraft when the horizontal distance from the Home Point exceeds 5 m. When the horizontal distance from the Home Point exceeds 16 m, the Home Point icon will stay on the edge of the Navigation Display.
  - ii. When the relative distance between the Home Point and the remote controller is less than 5 m, only the Home Point will be displayed in the Navigation Display. When the relative distance is more than 5 m, the remote controller will be displayed as a blue dot to indicate its position. When the horizontal distance between the remote controller and the aircraft exceeds 16 m, the remote controller position icon will stay on the edge of Navigation Display.
  - iii. When the compass of the remote controller is working normally, the blue dot shows the direction of the remote controller. If the signal is poor during flight, point the arrow of the remote controller in the Navigation Display to the direction of the aircraft.
- d. Home Point Distance: Displays the horizontal distance between the Home Point and the aircraft.

- e. **PinPoint Information:** Displays the name of the PinPoint and the horizontal distance from the aircraft to the PinPoint, when PinPoint is enabled.

Displays the name of the waypoints, the horizontal distance from the aircraft to the waypoint, and the ascending or descending trajectory of the flight route, during a flight route.

**Vertical Obstacle Sensing Information:** When an obstacle is detected above or below the aircraft, an obstacle bar icon will appear. When the aircraft reaches the warning distance, the icon will glow red and orange. When the aircraft reaches the obstacle braking distance, the icon will glow red.

**Horizontal Obstacle Sensing Information:** The light areas are the obstacle sensing areas of the aircraft, while the dark areas are the blind spots. During flight, keep the aircraft speed vector line out of the obstacle-sensing blind spots. When the aircraft reaches the warning distance, the arc will glow orange. When the aircraft reaches the obstacle braking distance, the arc will glow red. When the obstacle sensing is disabled, OFF will be displayed.

### 13. Map View

Tap to switch to map view.

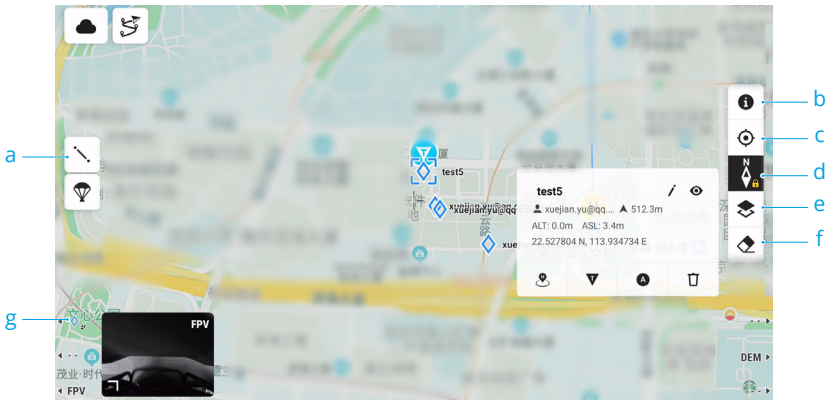

- Tap to draw lines on the map.
- GEO Zone Layer Management.
- Recenter Button: Tap to quickly center the remote controller in the view.
- Tap to lock the map rotation with north pointing upward.
- Map Layer Selection: Tap to select a satellite or street map (standard mode) according to operation requirements.
- Tap to clear the flight track of the aircraft.
- PinPoint: Press the L1 button on the remote controller to add a PinPoint in the center of the view. The altitude is the current altitude of the aircraft. Tap the PinPoint to check the distance from the aircraft, the altitude, and the coordinates. The PinPoint can be set as Home Point, pin and alternate site. Setting the PinPoint as a pin will make it easier to

display in the live view and map view, increasing efficiency. Tap to expand the PinPoint settings panel, which allows users to change the PinPoint name, color, coordinates, and altitude.

#### 14. Parachute

Tap to open the parachute. Only open the parachute in the case of an emergency.

#### 15. Gimbal Tilt Adjustment Button

Tap to recenter the gimbal or tilt the gimbal downward. AR projection will be displayed simultaneously.

#### 16. Cloud Service

Display the cloud service status. When the icon is gray it indicates the cloud service is disabled, when the icon is white it indicates the cloud service is enabled. Tap to view more information.

#### 17. Flight Route

Tap to enter the flight route library to create, edit, and select a flight route.

### Route Plan

Flight route library can be accessed from the homepage of DJI Pilot 2, or by tapping the flight route library icon in the camera view. Tap Create a Route. Route can be created via Set Waypoints and Live Mission Rec.

### Set Waypoints

Tap on the map to add waypoints. Two waypoints or above can generate a route. After generating a route, configure the route and waypoint settings.

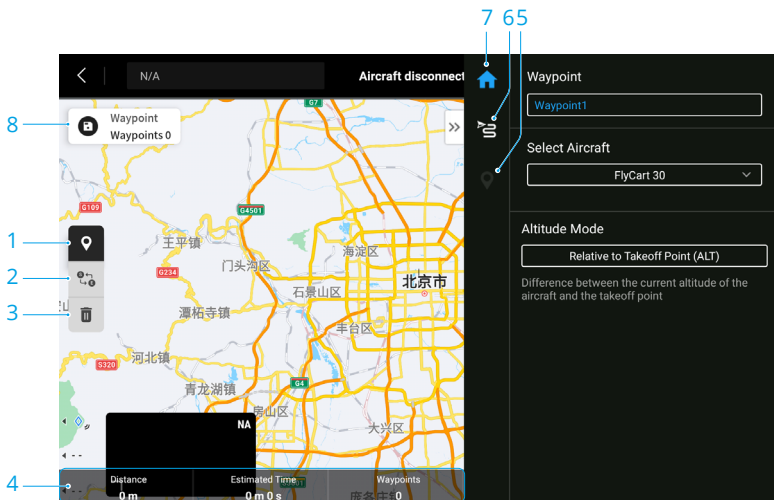

#### 1. Lock Waypoints

Tap to enable or disable waypoints, helping users avoid unexpected operation.

## 2. Reverse Path

Tap to swap the start and end points to reverse the flight path. S refers to the start point.

## 3. Delete Waypoints

Tap to delete the selected waypoints.

## 4. Flight Route Information

Displays the flight length, estimated flight time, and waypoint quantity.

## 5. Individual Waypoint Settings

Select a waypoint and set its parameters. The settings are applied to the selected waypoint, including aircraft speed, aircraft altitude, aircraft yaw mode, waypoint type, gimbal tilt, waypoint actions, longitude and latitude. It is recommended to select Follow Route for all the parameters.

## 6. Route Settings

The settings are applied to the entire route, including safe takeoff altitude, ascend to start point, aircraft speed, aircraft altitude, aircraft yaw, gimbal control, waypoint type, and completion action.

## 7. Parameters List

Edit the route name, advanced flight route settings, and altitude mode. Can also set the aircraft type.

## 8. Save

Tap to save the flight route.

## Live Mission Recording

Live mission recording uses the remote controller to add waypoints during the flight to record aircraft positions and generate a route.

## Flight Route Recording

Fly to the start point of the route and press the C1 button on the remote controller to set a waypoint while the aircraft is hovering in place. There will be a prompt when waypoint 1 is recorded successfully. Fly to the next waypoint and press C1 to record. Press C2 on the remote controller to delete a waypoint.

## Edit the Route

Tap to view the Library and select a flight route to preview. Tap settings and waypoint settings to edit a route. Tap the save button to generate the edited route.



- If the aircraft is using RTK positioning, the altitude information will be obtained automatically, DO NOT select Follow Route in this case.
  - The safe altitude for opening the parachute is 60 m. It is recommended to keep the aircraft altitude above 60 m when planning a route.
-

## Health Management System (HMS)

The HMS system includes the DJI Maintenance Program, DJI Care Delivery, Firmware Update, Manage Logs, and Error Records. If the aircraft is malfunctioning, check the corresponding issue in the Manage Logs section and contact DJI Support.

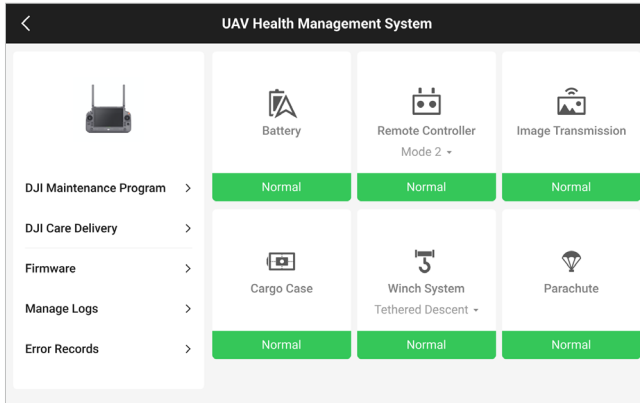

## Command and Control Link

The command and control (C2) link between the aircraft and remote controller is established using DJI O3 transmission technology with the two OcuSync antennas on the aircraft and DJI O3 image transmission system, offering a maximum transmission range of 20 km. Refer to the Specification section for its performance.

## Ground Operational Area Setup

It is recommended to take off the aircraft in an open area. When taking off, the operator should be more than 10 m away from the aircraft.

## Data Security

DJI DeliveryHub uploads, stores and manages data on cloud servers operated by Amazon Web Services, which are compliant with ISO/IEC 27001 security certifications.

### Data Collection

DJI will not access any user data before the user grants DJI permission to do so. You can grant or revoke the permission anytime in "Network Security Mode" or enable "Local Data Mode" to use your device completely offline.

## Data Transmission and Storage

Full-link encryption effectively protects data from third-party hijacking. Sensitive information, such as email addresses, mobile numbers, and locations, is protected with additional AES-256-CBC encryption.

### Clear All Device Data

You can choose to erase any data generated during your use of DJI devices. Using the DJI Pilot 2 app, you can clear the logs and cache on your device and the app, or restore the device to factory settings.

## Low Battery and Low Voltage Warnings

The aircraft features a low battery warning, critical low battery warning, critical low voltage warning, and safe flight assistance.

- When the low battery warning prompt appears in the app, fly the aircraft to a safe area and land as soon as possible. Stop the motors and replace the battery.
- The aircraft will automatically descend and land when the critical low voltage warning prompt appears in the app. Landing cannot be cancelled.
- If the Safe Flight Assistance is enabled in DJI Pilot 2, when the aircraft detects that the battery level is only enough to fly to the Home Point or an alternate landing site, it will fly to the alternate landing site (default setting) or return to home.



- Users can set the threshold of low battery warnings in the app.

## RTK Functions

The aircraft has an onboard RTK. The heading reference of the aircraft from the dual antennas of the onboard RTK is more accurate than a standard compass sensor and can withstand magnetic interference from metal structures and high-voltage power lines. When there is a strong GNSS signal, the dual antennas activate automatically to measure the heading of the aircraft.

The aircraft supports centimeter-level positioning to improve delivery operation when used with the DJI D-RTK 2 Mobile Station. Follow the instructions below to use the RTK functions.

### Enable/Disable RTK

Before each use, make sure that the RTK signal source is correctly set to either D-RTK 2 Mobile Station or Network RTK. Otherwise, RTK cannot be used for positioning. Go to Camera View in the app, tap **•••**, **RTK** and select RTK to view and set.

Disable RTK Positioning if RTK is not in use. Otherwise, the aircraft is not able to take off when there is no differential data.

## Using with the DJI D-RTK 2 Mobile Station

1. Refer to the D-RTK 2 Mobile Station User Guide for more information about linking the aircraft and the mobile station and setting up the mobile station.
2. Power on the mobile station and wait for the system to start searching for satellites. The RTK status icon on top of the Camera View in the app will become white to indicate that the aircraft has obtained and is using the differential data from the mobile station.

## Using with the Network RTK Service

The Network RTK service uses the remote controller instead of the base station to connect to an approved Network RTK server for differential data. Keep the remote controller powered on and connected to the internet when using this function.

1. Make sure the remote controller is connected to the internet.
2. In the app, go to Camera View, tap **•••** > **RTK** to select RTK Signal Type to Network RTK.
3. Tap Check Plan Coverage to make sure Network RTK signal coverage is available in the area where the aircraft will be used. Tap RTK Service Center and follow the instructions to purchase and activate the service.
4. Wait for the remote controller to be connected to the Network RTK server. The RTK status icon at the top of the Camera View in the app will turn white, indicating that the aircraft has obtained and used the RTK data from the server.



## Aircraft LEDs

There are LEDs on the frame arms marked M1 to M4. The LEDs on M1 and M2 are the front LEDs and glow red during flight to indicate the front of the aircraft. The LEDs on M3 and M4 are the rear LEDs and glow green during flight to indicate the rear of the aircraft.

All the LEDs are turned off when the aircraft is grounded. The front LEDs blink quickly in red and the rear LEDs blink quickly in green when the motors start spinning. Make sure to take off immediately.

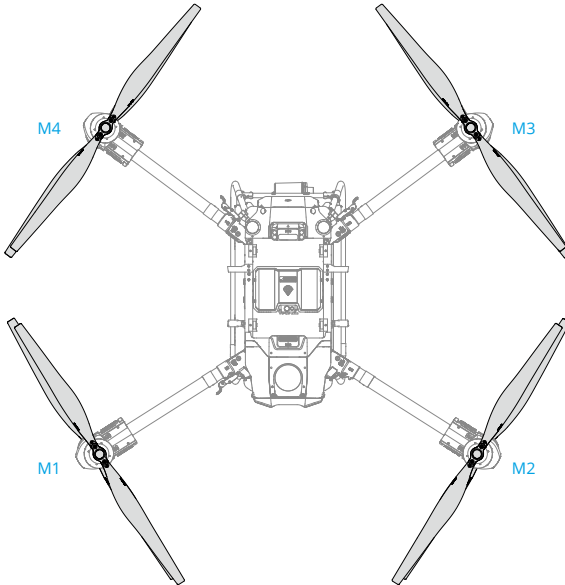

## Parachute

FlyCart 30 is equipped with an onboard parachute, and it can be opened manually or automatically when the aircraft is malfunctioning or if there is an emergency.

Opening the Parachute

1. Using the remote controller: In the Camera View of DJI Pilot 2, tap the parachute icon  to open the parachute.
2. When the aircraft is malfunctioning or loses power, the parachute will open automatically.



- The parachute can only be used once. Contact DJI Support to replace the parachute after use.
- The optimal safe altitude for opening the parachute is 60 m above the sea. If the parachute is opened at an altitude of below 60 m, it may not be able to protect the aircraft as intended.

## Propellers

The aircraft comes with 5420 High-Altitude Propellers. The 5420 propellers come in CCW and CW designations, and they must be mounted to the corresponding motors marked CCW and CW. Otherwise, it will cause aircraft damage or the aircraft will fail to take off. Replace the propellers in pairs.

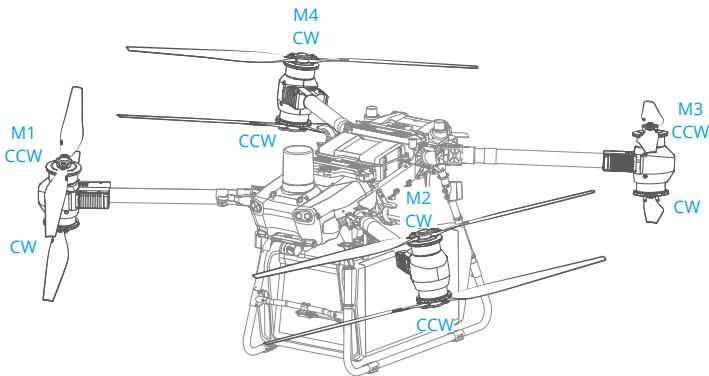

The High-Altitude Propellers can be used from 0 to 6000 m above sea level. The payload of the aircraft varies when it flies at different altitudes. For example, the max payload is 25 kg when the aircraft flies at 0 m sea level altitude. When flying between 0 and 3000 m, the max payload progressively increases with the flight altitude, and the max payload is 30 kg when the aircraft flies at 3000 m. When flying between 3000 and 6000 m, the max payload progressively decreases with the flight altitude, and the max payload is 0 kg when flying at 6000 m. Refer to the table below to arrange cargo delivery appropriately.

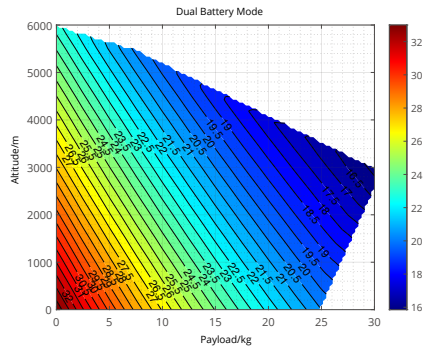
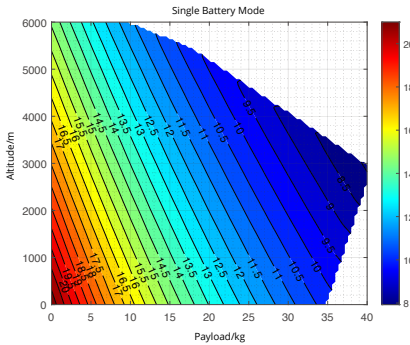

- Only use official DJI propellers. DO NOT mix propeller types.
- Propellers are consumable components. Purchase additional propellers if necessary.
- Make sure the propellers are mounted correctly and firmly. Check if the washers are worn.
- Make sure that all propellers are in good condition before each flight. DO NOT use aged, chipped, or broken propellers.
- To avoid injury, stay away from rotating propellers or motors.
- The propeller blades are sharp. Handle with care.

# Performance and Limitations

## Performance

Refer to the Specification section for FlyCart 30 performance.

## Prohibited Maneuvers

The following actions are prohibited.

1. Be under the influence of alcohol, drugs, or anesthesia, or suffering from dizziness, fatigue, nausea, or any other conditions, whether physical or mental, that could impair your ability to operate the aircraft safely.
2. Stop the motors mid-flight. NOTE: this is not prohibited in an emergency situation where doing so will reduce the risk of damage or injury.
3. Upon landing, power off the remote controller before powering off the aircraft.
4. Drop, launch, fire, or otherwise project any dangerous payloads on or at any buildings, persons, or animals, or which could cause personal injury or property damage.
5. Fly the aircraft recklessly without any plan.
6. Use this product for any illegal or inappropriate purpose such as spying, military operations, or unauthorized investigations.
7. Use this product to defame, abuse, harass, stalk, threaten, or otherwise violate the legal rights of others, such as the right of privacy and publicity.
8. Trespass onto private property of others.

# Normal Procedures

## Airspace Environment

Make sure to have training and practice before operating any actual flight. Practice with the simulator in DJI Assistant 2 or fly under the guidance of experienced professionals. Pick a suitable area to fly in according to the following flight requirements and restrictions. Fly the aircraft below 120 m (400 ft). Any flight altitude higher than that may violate local laws and regulations. Make sure you understand and comply with the local laws and regulations before flying. Read the Safety Guidelines carefully to understand all safety precautions before flying.

## Flight Environment Requirements

1. DO NOT use the aircraft in adverse weather conditions such as snow, fog, winds exceeding 12 m/s, or heavy rain exceeding 24.9 mm in 24 hours.
2. Only fly in open areas. Tall buildings and steel structures may affect the accuracy of the compass and the GNSS signal.
3. Pay attention to utility poles, power lines, and other obstacles. DO NOT fly near or above water, people, or animals.
4. Try to maintain VLOS of the aircraft at all times, and avoid flying near obstacles, crowds, animals, and bodies of water.
5. Avoid flying in areas with high levels of electromagnetism, including around mobile phone base stations and radio transmission towers.
6. DO NOT fly at more than 6 km (19,685 ft) above sea level.
7. DO NOT exceed the recommended payload weight limit when adding cargo to the cargo case. Otherwise, flight safety may be affected.
8. Make sure that there is a strong GNSS signal and the GNSS antennas are unobstructed during operation.
9. DO NOT operate the aircraft indoors.

## Flight Recorder

Flight data is automatically recorded to the internal storage of the aircraft. You can connect the aircraft to a computer via the USB port and export this data via DJI Assistant 2 or DJI Pilot 2 app.

## Flight Restrictions and Unlocking

### GEO (Geospatial Environment Online) System

The DJI Geospatial Environment Online (GEO) system is a global information system that provides real-time information on flight safety and restriction updates and prevents UAVs from

flying in restricted airspace. Under exceptional circumstances, restricted areas can be unlocked to allow flight. Prior to that, the user must submit an unlocking request based on the current restriction level in the intended flight area. The GEO system may not fully comply with local laws and regulations. Users shall be responsible for their own flight safety and must consult with the local authorities on the relevant legal and regulatory requirements before requesting to unlock a flight in a restricted area.

## GEO Zones

DJI's GEO System designates safe flight locations, provides risk levels and safety notices for individual flights and offers information on restricted airspace. All restricted flight areas are referred to as GEO Zones, which are further divided into Restricted Zones, Authorization Zones, Warning Zones, Enhanced Warning Zones, and Altitude Zones. Users can view such information in real-time in the DJI Pilot 2 app. GEO Zones are specific flight areas, including but not limited to airports, large event venues, locations where public emergencies have occurred (such as forest fires), nuclear power plants, prisons, government properties, and military facilities. By default, the GEO system limits takeoffs and flights in zones that may cause safety or security concerns. A GEO Zone map that contains comprehensive information on GEO Zones around the globe is available on the official DJI website: <https://fly-safe.dji.com>

## Flight Restrictions in GEO Zones

The following section describes in detail the flight restrictions for the above-mentioned GEO Zones.

GEO Zone	Flight Restriction	Scenario
Restricted Zones (Red)	UAVs are prohibited from flying in Restricted Zones. If you have obtained permission to fly in a Restricted Zone, please visit <a href="https://www.dji.com/flysafe">https://www.dji.com/flysafe</a> or contact <a href="mailto:flysafe@dji.com">flysafe@dji.com</a> to unlock the zone.	Takeoff: The aircraft motors cannot be started in Restricted Zones.
		In Flight: When the aircraft flies inside a Restricted Zone, a 100-second countdown will commence in DJI Pilot 2. When the countdown is finished, the aircraft will land immediately in semi-automatic descent mode and turn off its motors after landing. When the aircraft approaches the boundary of a Restricted Zone, the aircraft will automatically decelerate and hover.

<p>Authorization Zones (Blue)</p>	<p>The aircraft will not be able to take off in an Authorization Zone unless permission has been obtained to fly in the area.</p>	<p>Takeoff: The aircraft motors cannot be started in Authorization Zones. To fly in an Authorization Zone, the user is required to submit an unlocking request registered with a DJI-verified phone number.</p> <p>In Flight: When the aircraft flies inside an Authorization Zone, a 100-second countdown will commence in DJI Pilot 2. When the countdown is finished, the aircraft will land immediately in semi-automatic descent mode and turn off its motors after landing.</p>
<p>Warning Zones (Yellow)</p>	<p>A warning will be displayed when the aircraft flies inside a Warning Zone.</p>	<p>The aircraft can fly in the zone but the user is required to understand the warning.</p>
<p>Enhanced Warning Zones (Orange)</p>	<p>When the aircraft flies in an Enhanced Warning Zone, a warning will be displayed, prompting the user to confirm the flight path.</p>	<p>The aircraft can continue to fly once the warning is confirmed.</p>
<p>Altitude Zones (Gray)</p>	<p>The altitude of the aircraft is limited when flying inside an Altitude Zone.</p>	<p>When the GNSS signal is strong, the aircraft cannot fly above the altitude limit. When the aircraft approaches the boundary of an Altitude Zone and the GNSS signal is strong, the aircraft will decelerate automatically and hover if the aircraft is above the altitude limit.</p> <p>When the GNSS signal changes from weak to strong, a 100-second countdown will commence in DJI Pilot 2 if the aircraft exceeds the altitude limit. When the countdown is finished, the aircraft will descend below the altitude limit and hover.</p>



- Semi-Automatic Descent: All stick commands except the throttle stick command and the RTH button are available during descent and landing. The aircraft motors will turn off automatically after landing. It is recommended to fly the aircraft to a safe location during semi-automatic descent.

## Buffer Zone

Buffer Zones for Restricted Zones/Authorization Zones: To prevent the aircraft from accidentally flying into a Restricted or Authorization Zone, the GEO system creates a buffer zone of about 20 meters wide outside each Restricted and Authorization Zone. As shown in the illustration below, the aircraft can only take off and land away from Restricted or Authorization Zones when inside the buffer zone. The aircraft cannot fly toward the Restricted or Authorization Zone unless an

unlocking request has been approved. The aircraft cannot fly back into the buffer zone after leaving the buffer zone.

Buffer Zones for Altitude Zones: A buffer zone of about 20 meters wide is established outside each Altitude Zone. As shown in the illustration below, when approaching the buffer zone of an Altitude Zone in a horizontal direction, the aircraft will gradually reduce its flight speed and hover outside the buffer zone. When approaching the buffer zone from underneath in a vertical direction, the aircraft can ascend and descend in altitude or fly away from the Altitude Zone. The aircraft cannot fly toward the Altitude Zone. The aircraft cannot fly back into the buffer zone in a horizontal direction after leaving the buffer zone.

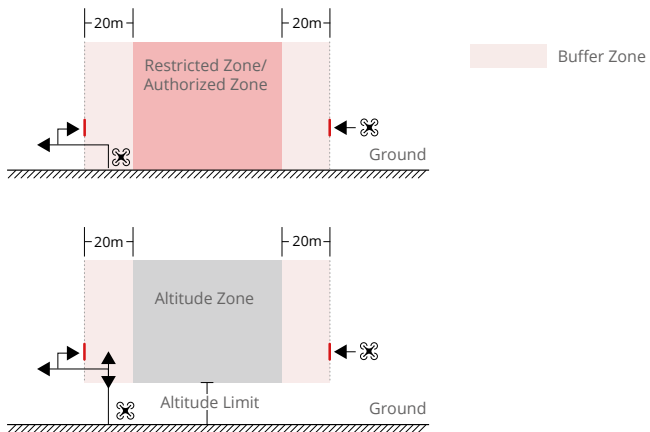

## Unlocking GEO Zones

To satisfy the needs of different users, DJI provides two unlocking modes: Self-Unlocking and Custom Unlocking. Users may make either type of request on the DJI Fly Safe website or via a mobile device.

Self-Unlocking is intended for unlocking Authorization Zones. To complete Self-Unlocking, the user is required to submit an unlocking request via the DJI Fly Safe website at <https://fly-safe.dji.com>. Once the unlocking request is approved, the user may synchronize the unlocking license through the DJI Pilot 2 app (Live Self-Unlocking) to unlock the zone; alternatively, the user may launch or fly the aircraft directly into the approved Authorization Zone and follow the prompts in DJI Pilot 2 to unlock the zone (Scheduled Self-Unlocking). For Live Self-Unlocking, the user can designate an unlocked period during which multiple flights can be operated. Scheduled Self-Unlocking is only valid for one flight. If the aircraft is restarted, the user will need to unlock the zone again.

Custom Unlocking is tailored for users with special requirements. It designates user-defined custom flight areas and provides flight permission documents specific to the needs of different users. This unlocking option is available in all countries and regions and can be requested via the DJI Fly Safe website at <https://fly-safe.dji.com>.



Unlocking on a Mobile Device: Run the DJI Pilot 2 app and tap GEO Zone Map on the home screen. View the list of the unlocking licenses and tap to view details of the unlocking license. A link to the unlocking license and a QR code will be displayed. Use your mobile device to scan the QR code and apply to unlock directly from the mobile device.

For more information about unlocking, please visit <https://fly-safe.dji.com> or contact [flysafe@dji.com](mailto:flysafe@dji.com).

## Maximum Altitude & Distance Restrictions

Maximum flight altitude restricts the aircraft flight altitude, while maximum flight distance restricts the aircraft flight radius around the Home Point. These limits can be set using the DJI Pilot 2 app for improved flight safety.

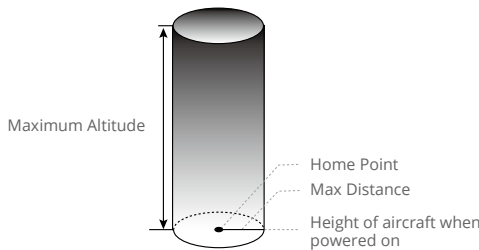

Home Point not manually updated during flight

Strong GNSS Signal		
	Flight Restrictions	Prompt in DJI Pilot 2
Max Altitude	Altitude of the aircraft cannot exceed the value set in DJI Pilot 2.	Aircraft approaching max flight altitude. Fly with caution.
Max Distance	The straight-line distance from the aircraft to the Home Point cannot exceed the max flight distance set in DJI Pilot 2.	Aircraft approaching max flight distance. Fly with caution.
Weak GNSS Signal		
	Flight Restrictions	Prompt in DJI Pilot 2
Max Altitude	The flight altitude cannot exceed the max flight altitude set in DJI Pilot 2.	Aircraft approaching max flight altitude. Fly with caution.
Max Distance	No limit	N/A



- If an aircraft exceeds a specified limit, the pilot can still control the aircraft but cannot fly any closer to the restricted area.
- For safety reasons, DO NOT fly the aircraft close to airports, highways, railway stations, railway lines, city centers, or other sensitive areas. Only fly the aircraft within a visual line of sight.

## DJI AirSense

Airplanes with an ADS-B transceiver will actively broadcast flight information including location, flight path, speed, and altitude. DJI aircraft that have DJI AirSense technology are capable of receiving flight information broadcasts from ADS-B transceivers that comply with 1090ES or UAT standards within a radius of 10 kilometers. Based on the received flight information, DJI AirSense can analyze and obtain the location, altitude, orientation, and velocity of the surrounding crewed airplanes, and compare such figures with the current position, altitude, orientation, and velocity of the DJI aircraft to calculate in real-time the potential risk of collision with the surrounding crewed airplanes. DJI AirSense will then display a warning message in DJI Pilot 2 according to the risk level.

DJI AirSense only issues warning messages on approaches by specific crewed airplanes under special circumstances. Always fly the aircraft within your visual line of sight and take precautions at all times to ensure flight safety. Please be aware that DJI AirSense has the following limitations:

1. DJI AirSense can only receive messages sent by airplanes with an ADS-B Out device that is in compliance with 1090ES (RTCA DO-260) or UAT (RTCA DO-282) standards. DJI devices cannot receive broadcast messages from or display warnings from airplanes not equipped with properly functioning ADS-B Out devices.
2. If there is an obstacle between a crewed aircraft and a DJI aircraft, DJI AirSense will not be able to receive ADS-B messages from the aircraft or send warnings to the user. Keenly observe your surroundings and fly with caution.
3. Warning prompts may appear with delay if DJI AirSense experiences any interference from the surrounding environment. Keenly observe your surroundings and fly with caution.
4. Warning prompts may not appear if the DJI aircraft is unable to obtain information on its own location.
5. DJI AirSense cannot receive ADS-B messages from crewed airplanes or send warnings to the user when it is disabled or misconfigured.

When a risk is detected by the DJI AirSense system, the AR projection display will appear on the current view in DJI Pilot 2, showing the distance between the DJI aircraft and the airplane, while also sending a warning. Users should follow the instructions in DJI Pilot 2 upon receiving the alert.

- a. **Notice:** A blue airplane icon will appear on the map.
- b. **Caution:** The app will display the message: Crewed aircraft detected nearby. Fly with caution. A small square, orange icon with the distance information will appear on the camera view, and an orange airplane icon will appear on the map view.
- c. **Warning:** The app will display the message: Collision Risk. Descend or Ascend Immediately. If the user does not operate the aircraft, the app will display the message: Collision Risk. A small square, red icon with the distance information will appear on the camera view, and a red airplane icon will appear on the map view. The remote controller will vibrate to alert the user.

## Radio Frequency Environment

1. Fly in open areas. Tall buildings, steel structures, mountains, rocks, or forests may affect the accuracy of the on-board compass and block both GNSS and remote control signals.
2. Avoid using wireless devices such as mobile devices with Bluetooth, Wi-Fi, etc., that use the same frequency bands as the remote controller.
3. When using with multiple aircrafts, make sure that the distance between each aircraft is more than 10 m to avoid interference. Pay attention to the interference prompts and adjust the distance of the aircraft accordingly.
4. The sensitivity of the radar module may be reduced when operating several aircraft within a short distance. Operate with caution.
5. Be alert when flying near areas with magnetic or radio interference. These include, but are not limited to, high voltage lines, large scale power transmission stations or mobile base stations, and broadcasting towers. Failing to do so may compromise the transmission quality of this product or cause transmission errors which may affect flight orientation and location accuracy. The aircraft may behave abnormally or go out of control in areas with too much interference.

## Use of Launch and Recovery Equipment

Not applicable.

## Distance to Control Station

When taking off or landing, the aircraft should be more than 10 m away from the remote controller and operator to ensure safety. Maintain visual line of sight with the aircraft at all times.

## System Assembly

### Preparing the Remote Controller

#### Charging the Remote Controller

Use the DJI USB-C Power Adapter (100W) to charge the remote controller. The internal battery of the remote controller must be charged to activate it before first use. The battery level LEDs will flash to indicate that the internal battery has been activated and charging has started.

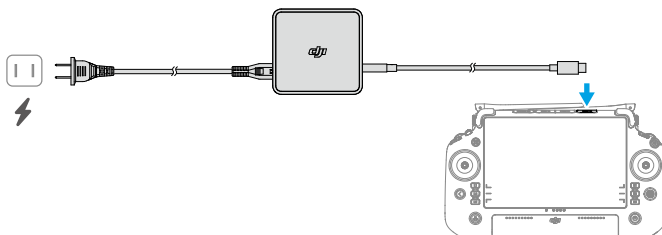

- 
- 💡 • The remote controller cannot be powered on before activating the internal battery.
- 

#### Checking the Battery Level

While the remote controller is powered off, press once on the power button to check the battery level of the internal battery.

#### Powering On/Off

Press once, then press and hold to power the remote controller on/off. The remote controller needs to be activated before using it for the first time. Follow the prompts to activate.

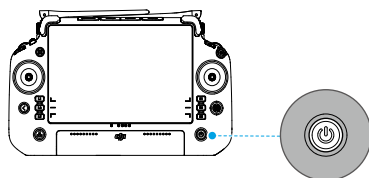

## Adjusting the Antennas

Unfold and adjust the antennas. The signal strength of the remote controller is affected by the position of the antennas.

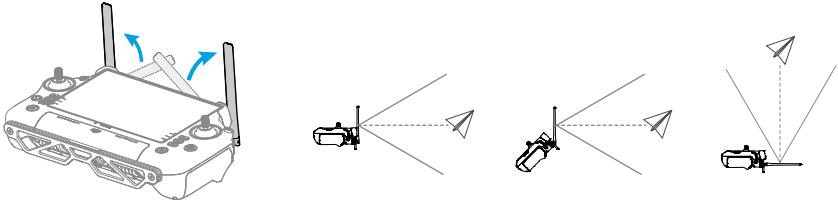

## Attaching the Strap

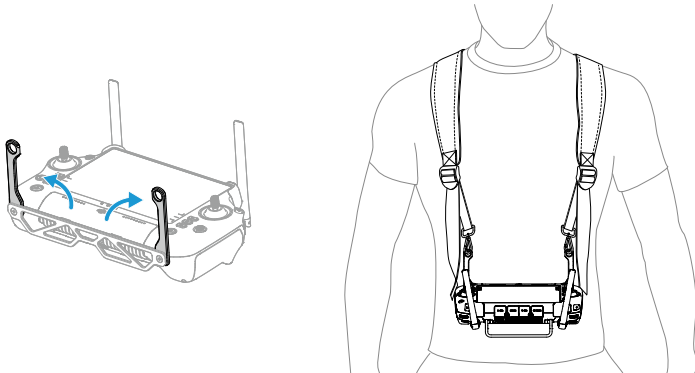

1. Unfold the strap connector brackets.
2. While wearing the strap, attach the strap hooks to the bracket holes.



- After use, hold the remote controller with one hand and unlatch the strap hooks from the brackets. Put the remote controller down, and then take off the strap.

## Preparing the Aircraft

### Charging DB2000 Intelligent Flight Batteries

Use the C8000 Intelligent Battery Station to charge DB2000 Intelligent Flight Batteries. The C8000 Intelligent Battery Station needs to be activated before being used for the first time, and DB2000 Intelligent Flight Batteries need to be activated using the C8000 Intelligent Battery Station.

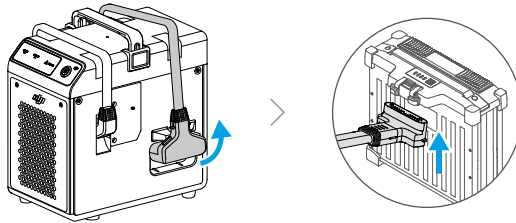

• Refer to the C8000 Intelligent Battery Station User Guide for more information.

---

## Unfolding the Aircraft

- Unfold and lock the M3 and M4 frame arms ①② before unfolding and locking the M1 and M2 frame arms ③④. Ensure all arm locks are secure. For easier unfolding, try moving the propellers (while still in the propeller holder) away from the frame arms before moving the frame arms away from the body of the aircraft.
- Remove the propeller holder.
- Unfold the propellers.

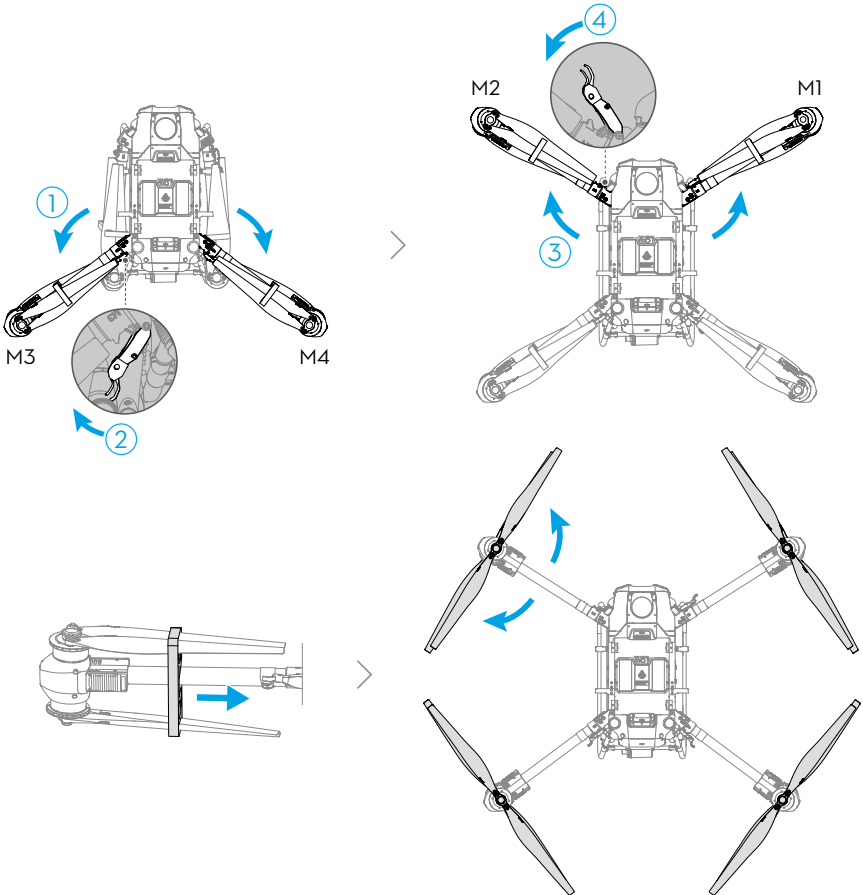

## Installing the Intelligent Flight Battery

Install the two batteries as shown in the diagram. Press down the battery until you hear two clicks.

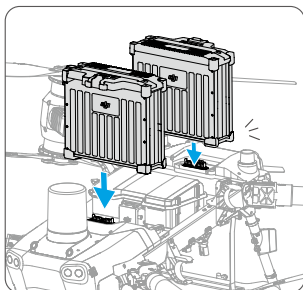

Checking the battery level: Press the power button once.

Power on/off: Press once, then press and hold the power button.

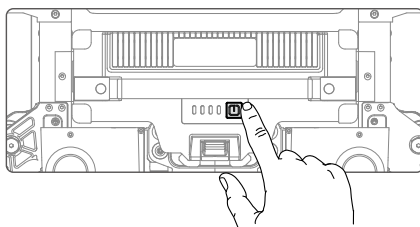

## Activating the Aircraft

Power on the aircraft and remote controller, then launch DJI Pilot 2 and follow the on-screen instructions to activate the aircraft.

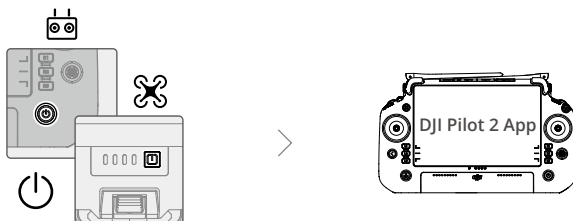

- ⚠ • Make sure the battery is firmly mounted. Make sure the battery is powered off during installation.
- To remove the battery, press the battery buckle and lift the battery.
- To fold the frame arms, fold the M1 and M2 frame arms before folding M3 and M4.



## Using the Cargo Case

Pull the lock to open and close the cargo case.

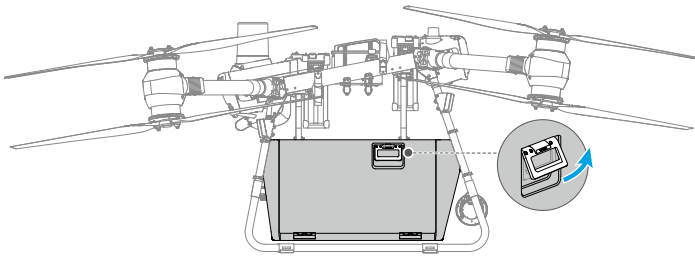

## Pre-Flight Checklist

1. Make sure the remote controller and the aircraft batteries are fully charged.
2. Make sure the Intelligent Flight Batteries and cargo case are firmly mounted.
3. Make sure all parts are mounted securely.
4. Make sure all cables are connected properly and securely.
5. Make sure propellers are securely mounted, that there are no foreign objects in or on the motors and propellers, and that the propeller blades and arms are unfolded and the arm locks are tight. Make sure the propellers and the washers are in good condition.
6. Make sure the FPV camera and binocular vision systems are clean and in good condition.
7. Make sure the Preflight Check in DJI Pilot 2 app has no warnings and all settings are appropriate.

## System Starting (Basic Flight)

1. Place the aircraft on open, flat ground with the rear of the aircraft facing you.
2. Lock the cargo case after placing the cargo inside.
3. Power on the remote controller and aircraft, then launch DJI Pilot 2.
4. Make sure the remote controller is linked to the aircraft and it is functioning normally.
5. If using RTK for positioning, make sure that the RTK signal source is set correctly (D-RTK 2 Mobile Station or Network RTK service). Go to the camera view in the DJI Pilot 2 app, tap **...** and **RTK** to view and set RTK signal source. Set the RTK signal source to None if RTK positioning is not in use. Otherwise, the aircraft cannot take off when there is no differential data.
6. Wait for satellite search results. Make sure that there is a strong GNSS signal, and make sure the aircraft heading measurements, taken using the dual antennas, are ready. Perform the Combination Stick Command (CSC) to start the motors. If the dual antennas are not ready after waiting for an extended period, move the aircraft to an open area with a stronger GNSS signal.

7. Push the throttle stick up slowly to take off.
8. Make sure the aircraft has exited the flight route and the aircraft can be controlled manually before landing. Pull down the throttle stick slowly and land the aircraft on flat ground.
9. After landing, pull down the throttle stick and hold it in that position until the motors stop.
10. After the motors stop, power off the aircraft before turning off the remote controller.

-  • When the low battery warning prompt appears in the app, fly the aircraft to a safe area and land as soon as possible. Stop the motors and replace the battery. The aircraft will automatically descend and land when the critical low battery warning prompt appears in the app.
- 

## Calibrating the Compass

-  • It is important to calibrate the compass. The calibration result affects the flight safety. The aircraft may malfunction if the compass is not calibrated.
- DO NOT calibrate the compass where there is a chance of strong magnetic interference. This includes areas where there are utility poles or walls with steel reinforcements.
  - DO NOT carry ferromagnetic materials with you during calibration such as keys or a mobile phone.
  - After successful calibration, the compass may act abnormally when you place the aircraft on the ground. This may be because of magnetic interference underground. Move the aircraft to another location and try again.
- 

Calibrate the compass when prompted by the app. It is recommended to calibrate the compass with an empty cargo case.

1. Tap **•••** >  > Sensor Status > Compass > Calibrate Compass.
2. Hold the aircraft horizontally and rotate it 360° around a vertical axis with the aircraft approximately 1.2 m above the ground. Calibration is complete when the app displays that calibration was successful.
3. If the app displays a tilted aircraft, it indicates that the horizontal calibration failed. Users should tilt the aircraft and rotate it horizontally. Calibration is completed when the app displays that calibration was successful. To reduce the number of rotations required, the aircraft should be tilted at least 45°.
4. Retry if the calibration fails.

## Takeoff/Landing

### Takeoff

The Combination Stick Command (CSC) is used to start the motors. Push both sticks to the bottom inner or outer corners to start the motors. Once the motors start spinning, release both sticks simultaneously and take off as soon as possible. **DO NOT** start the motors if not planning to take off right away, otherwise the aircraft may lose, drift or even take off automatically and cause harm or damage.

- ⚠️ • There is a six-second countdown and ESC beeping before the motor starts after performing the CSC.

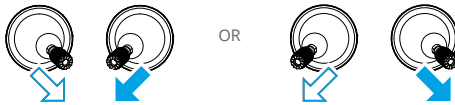

### Landing

There are two ways to stop the motors:

- When the aircraft has landed, push and hold the throttle stick down until the motors stop. (Recommended).



Throttle Stick (left control stick in Mode 2)

- When the aircraft has landed, perform the same CSC used to start the motors until the motors stop. Release both sticks once the motors have stopped.

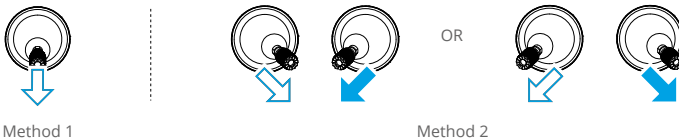

Method 1

Method 2

- ⚠️ • Spinning propellers are dangerous. Stay away from spinning propellers and motors to avoid injury during takeoff or landing.
- Make sure to keep hold of the remote controller and remain in control of the aircraft until the motors stop.
  - **DO NOT** stop the motors mid-flight, or it will cause the aircraft to crash. The motors should only be stopped mid-flight if an emergency situation occurs, such as if the aircraft is involved in a collision.

- It is recommended to use Method 1 to stop the motors. When using Method 2 to stop the motors, the aircraft may roll over if it is not completely grounded. Use Method 2 with caution.
  - After landing, power off the aircraft before turning off the remote controller.
- 

## Cruise/Maneuvering Flight

### Flight Modes

The flight controller system of the aircraft supports the following flight modes. The aircraft will fly in N-mode (Normal) by default.

**N-mode (Normal):** The aircraft utilizes GNSS or the RTK module for positioning. When the GNSS signal is strong, the aircraft uses GNSS for positioning. When the RTK module is enabled and the differential data transmission is strong, it provides centimeter-level positioning. It will revert to Attitude mode when the GNSS signal is weak or when the compass experiences interference.

**S-mode (Sport):** The aircraft utilizes GNSS or the RTK module for positioning. By adjusting the gain and expo settings, the maximum flight speed of the aircraft can be increased to 20 m/s. The obstacle sensing performance will be reduced in S-mode. Fly with caution.

**F-mode (Winch System):** F-mode is based on N-mode. The flight speed is limited to allow easier control of the aircraft. It is suitable to use when the aircraft position needs to be adjusted slightly, such as before the winch system releases cargo.

If ASN mode has been selected in DJI Pilot 2, switch to F-mode to enter Attitude mode (A-mode). In this mode, GNSS is not used for positioning and the aircraft can only maintain altitude using the barometer. The flight speed in A-mode depends on the surroundings of the aircraft, such as wind speed.

### Attitude Mode Warning

In A-mode, the aircraft cannot position itself and is easily affected by its surroundings, which may result in horizontal shifting. Use the remote controller to position the aircraft.

Maneuvering the aircraft in A-mode can be difficult. Make sure you are sufficiently familiar with the aircraft behavior in A-mode. DO NOT fly the aircraft too far away to avoid unnecessary risks. Avoid flying in areas where GNSS signal is weak or in narrow and confined spaces. Otherwise, the aircraft will be forced to enter Attitude mode, leading to potential flight hazards. Land the aircraft in a safe place as soon as possible.



- Obstacle sensing performance is reduced in S-mode. Pay attention to the surrounding environment and obstacles on the route when flying the aircraft in S-mode.
- Please note that when flying in S-mode, the flight speed of the aircraft will greatly increase compared with that in N-mode (Normal). Accordingly, the braking distance will also increase significantly. When flying in a windless environment, a minimum braking distance of 50 m (164 ft) is required.
- DO NOT switch from N-mode to either S-mode or A-mode unless you are sufficiently familiar with the aircraft behavior under each flight mode.

- When switching GNSS to the BeiDou satellite positioning system in DJI Pilot 2, the aircraft only will only use a single positioning system and the satellite search capability will become poor. Fly with caution.

## Return to Home

Return to Home (RTH) brings the aircraft back to the last recorded Home Point when the positioning system is functioning normally. There are three types of RTH: Smart RTH, Low Battery RTH, and Failsafe RTH.

The aircraft automatically flies back to the Home Point and lands when Smart RTH is initiated, the aircraft enters Low Battery RTH, or the video link signal is lost during flight if the Home Point is recorded during takeoff and the GNSS signal is strong.



- Home Point: The Home Point is recorded when the GNSS icon is white during takeoff or flight.

## Smart RTH

Press and hold the RTH button on the remote controller to initiate Smart RTH. The orientation of the aircraft cannot be controlled during RTH. Use the remote controller to control the flight altitude of the aircraft to avoid collision during the RTH process. Press the RTH button to exit Smart RTH and regain full control of the aircraft.

### Smart RTH Procedure

1. The Home Point is recorded.
2. RTH is triggered, for example, Smart RTH or Low Battery RTH.
3. The Home Point is confirmed and the aircraft adjusts its orientation.
  - a. If more than 50 m (164 ft) from the Home Point and below the pre-set RTH altitude, the aircraft will ascend to the pre-set RTH altitude before flying to the Home Point. The aircraft will fly directly to the Home Point if it is above the pre-set RTH altitude.
  - b. When the distance is between 5 m (16.4 ft) and 50 m (164 ft) from the Home Point, the aircraft will fly to the Home Point at the current altitude.
  - c. When the distance is less than 5 m from the Home Point, the aircraft will land where it is.

## Low Battery RTH

If the Low Battery Action is set to RTH in the Aircraft Battery settings in the app, the aircraft will enter RTH automatically when the aircraft battery level reaches the low battery threshold.

During RTH, users can control the altitude of the aircraft to avoid collisions when returning to the Home Point. Press the RTH button once to exit RTH and regain control of the aircraft.

The aircraft will not enter RTH if the Low Battery Action is set to Warning in the Aircraft Battery settings in the app.

## Failsafe RTH

The failsafe action can be set to RTH, Hover or Land in the app when the remote controller signal is lost. If the failsafe action is set to RTH, the GNSS signal is strong (GNSS icon is white), the RTK module is working normally, and the Home Point was recorded successfully, the aircraft will fly to the Home Point when the remote controller signal is lost for more than three seconds. The aircraft will remain in RTH mode even after the remote controller signal has been restored. The user can use the remote controller to control the aircraft's flight speed and altitude, or exit RTH by pressing the RTH button on the remote controller.

### Failsafe RTH Procedure

1. The Home Point is recorded.
2. Failsafe RTH is triggered when the remote controller signal is lost for more than three seconds.
3. The Home Point is confirmed and the aircraft adjusts its orientation.
  - a. If more than 50 m (164 ft) from the Home Point and below the pre-set RTH altitude, the aircraft will ascend to the pre-set RTH altitude before flying to the Home Point. The aircraft will fly directly to the Home Point if it is above the pre-set RTH altitude.
  - b. When the distance is between 5 (16.4 ft) to 50 m (164 ft) from the Home Point, the aircraft will fly to the Home Point at the current altitude.
  - c. When the distance is less than 5 m from the Home Point, the aircraft will land where it is.

## Updating the Home Point

The Home Point can be updated in DJI Pilot 2 app during flight. There are two ways to set a Home Point:

1. Set the current coordinates of the aircraft as the Home Point.
2. Set the current coordinates of the remote controller as the Home Point.



- Make sure the space above the GNSS module of the remote controller is not obstructed and that there are no tall buildings around when updating the Home Point.
- 

Follow the instructions below to update the Home Point:

1. Go to DJI Pilot 2 and enter camera view.
2. Tap > and select to set the current coordinates of the aircraft as a Home Point. Select to set the current coordinates of the remote controller as the Home Point.



- The RTH feature will be disabled when GNSS signal is weak (when the GNSS icon is red, or GNSS is unavailable).
- 

## Obstacle Avoidance During RTH

In an optimal operating environment, obstacle avoidance during RTH is available. If there is an obstacle within 20 m of the aircraft, the aircraft decelerates and then stops and hovers. The aircraft will exit the RTH procedure and wait for further commands.

## Landing Protection Function

Landing Protection activates during auto landing. The procedure is as follows:

1. After arriving at the home point, the aircraft descends to a position 3 m above the ground and hovers.
2. Control the pitch and roll sticks to adjust the aircraft position and make sure the area is suitable for landing.
3. Pull down the throttle stick or follow the onscreen instructions in the app to land the aircraft. The aircraft will land automatically if there is no command from the remote controller within 20 seconds.

## Alternate Landing

In the case of low battery or other abnormal situations, an alternate landing site can be set if the aircraft landing place is far away from the Home Point or the aircraft does not need to fly back to Home Point. The aircraft will fly to the alternate landing site after Alternate Landing is triggered. Alternate Landing can only be triggered automatically by the aircraft.

## Setting the Alternate Landing Site

Pin a point in the map on DJI Pilot 2 to set an alternate landing site. Up to five alternate landing sites can be set, including any three points, as well as the takeoff point and the end of the flight route (if flight route is enabled).

## Smart Low Battery Alternate Landing

If the battery level is not sufficient to complete a flight route, a prompt will appear in the app and a 10-second countdown will commence. The user can select an alternate landing site in the prompt or press cancel. The aircraft will fly to the selected alternate landing site along the flight route after the user has confirmed the choice. The aircraft will not fly to an alternate landing site if the user cancels the option, but will keep warning the user.

## Failsafe Alternate Landing

If the failsafe action is set to Alternate Landing in DJI Pilot 2, the aircraft will fly to an alternate landing site when the remote controller signal is lost during flight.

## Overheated Alternate Landing

If the failsafe action is set to Alternate Landing in the Preflight Check page of DJI Pilot 2, the aircraft will fly to alternate landing site when the aircraft overheats (such as IMU overheats).

## Alternate Landing Procedure

### Alternate Landing Procedure during Manual Flight

- a. If more than 5 m (16.4 ft) from the Home Point and below the pre-set RTH altitude, the aircraft will ascend to the pre-set RTH altitude before flying to the alternate landing site. The aircraft will fly directly to the alternate landing site if it is above the pre-set RTH altitude.
- b. If the aircraft is less than 5 m (16.4 ft) from the alternate landing site, it will fly directly to the alternate landing site at the current altitude.

If more than one alternate landing site is set, an alternate landing site can be selected in the 10 seconds after the Low Battery Alternate Landing prompt appears in the app. The aircraft will select an alternate landing site automatically if another type of alternate landing is triggered.

### Alternate Landing Procedure during Flight Route

- a. If the aircraft is less than 50 m (164 ft) from the nearest point of the flight route, it will fly to that nearest point and then fly along the flight route to the projected point above the alternate landing site. If the projected point is higher than the RTH altitude, the aircraft will fly to the projected point at current altitude. If the projected point is lower than the RTH altitude, the aircraft will ascend to the RTH altitude and fly to the projected point and land.
- b. If the aircraft is further than 50 m (164 ft) from the nearest point of the flight route, the alternate landing procedure is the same as the alternate landing procedure during manual flight.



- Projected Point: The projected point is the nearest point along the flight route above the alternate landing site.



- After the alternate landing is triggered, alternate landing site and alternate landing route cannot be changed.
- 

## Exit from Alternate Landing

- a. Press the flight pause button on the remote controller to exit from alternate landing.
- b. Alternate landing will be exited automatically when there is obstacle sensed or if a special situation occurs, such as approaching restricted zones, reaching maximum altitude or reaching maximum flight distance.
- c. RTK positioning is used by default during alternate landing. GNSS positioning will be used if RTK positioning is unavailable. Alternate landing will be exited automatically if GNSS is also unavailable.
- d. Alternate landing will be exited automatically if there is an abnormal situation such as the battery level is critically low or the motors have overheated.



- Alternate landing is not available when the GNSS signal is weak or unavailable.
  - Alternate landing route will be displayed in the app during alternate landing.
-



## System Shutdown

After landing, push the throttle stick down and hold to stop the motors. Press the power button and then press and hold to power off the aircraft and remote controller.

## Post-Flight Inspection

1. Make sure that the aircraft is powered off. Remove the battery from the aircraft and store it properly.
2. Check the aircraft structure, clean the dirt and dust, and replace any loose or damaged parts.
3. Make sure that the aircraft is folded correctly for transportation.
4. Make sure that the battery connector on the aircraft is clean and dry.

# Emergency Procedures

## Engine Failure

If one or more motors fail during flight, the aircraft will calculate the remaining propulsion according to factors such as the status of the propulsion system, aircraft weight, and flight environment. Two possible scenarios may occur:

1. Remaining propulsion is sufficient: The aircraft will continue to fly in a stable condition with remaining propulsion.
2. Remaining propulsion is insufficient: The aircraft will spin and perform a controlled descent. Afterward, it is recommended that users land the aircraft manually and check and repair the aircraft immediately.

## Fire

A prompt will appear in the app and the flight controller will reduce the power of the aircraft when the flight battery temperature is too high. The battery will be locked for future use if it exceeds the temperature threshold during flight and cannot be used again after landing.

Follow the instructions below if the flight battery catches fire.

1. If the battery catches fire when the battery is being charged using a battery station, make sure personal safety is guaranteed, power off the battery station immediately, and disconnect the battery from the charging device. If the battery catches fire when the battery is in the aircraft, make sure personal safety is guaranteed and disconnect the battery from the aircraft immediately.
2. Transfer the flammable materials surrounding the battery to a safe distance of more than 5 m away.
3. If the fire is small, use materials such as large amount of sand to cover the location of the fire and pour cold water to cool the battery until there is no longer any smoke being produced. With the help of fire-resistant gloves or other protective tools that allow users to avoid direct contact with the battery, move the battery to a container with enough water to fully immerse the battery and add an appropriate amount of salt to help fully discharge the battery. Leave the container in a cool place for more than 72 hours and take out the battery and discard it.
4. If the fire is large, double check that there are no flammable materials surrounding the fire, extend the safety distance to more than 10 m, and evacuate any people in the surrounding environment. Wait until the battery burns out and the fire is extinguished in order to avoid any further accidents.

## Loss of C2 Link

Failsafe RTH and Failsafe Alternate Landing will be triggered after the C2 link is lost. Refer to the Return to Home and Alternate Landing section for details.

## Loss of Navigation Systems

When using fixed RTK positioning, the aircraft will switch to GNSS if RTK is unavailable during flight. If GNSS is also unavailable, the aircraft will switch to Attitude (ATTI) mode automatically to stabilize its attitude and a prompt will appear in the app to remind users to fly with caution and land as soon as possible.

## Control Station Failures

Control station failures include the following scenarios.

1. Control signal is lost: the aircraft will enter Failsafe RTH if Failsafe RTH is enabled in the app. Refer to Loss of C2 Link for more information about Failsafe RTH. The aircraft action can also be set to hovering in place until the aircraft lands with critically low battery level or landing directly.
2. The app crashes during automatic operations while the control signal is normal: in this case, the C2 link between the aircraft and the remote controller is in good condition, so the aircraft will continue performing the current operation until landing is triggered by critically low battery level. Users can exit from Route operations by moving the control stick slightly and control the aircraft manually.

## Flyaway

The flight telemetry of the aircraft will be displayed on the screen of the remote controller during flight. If the aircraft flies away during operation, users can search for the aircraft according to the location of the aircraft and remote controller displayed on the map in the app. If the GNSS signal of the aircraft is lost after the aircraft flies away then the aircraft will not be displayed on the map in the app. Users can estimate the location of the aircraft to its last location, flight speed, and heading before the loss of the GNSS signal.

## Reporting Requirements

Users are responsible to inform DJI of any event of an uncontrolled crash or flyaway within 2 business days through DJI Support, a DJI authorized dealer, or other means and shall upload the flight data related to the event.

# Intelligent Flight Battery

## Introduction

The DB2000 Intelligent Flight Battery uses high-energy battery cells and an advanced power management system to provide long-lasting power to FlyCart 30 aircraft. The optimized battery cells and heat dissipation design effectively keep the temperature of the battery in check. The Intelligent Flight Battery has a capacity of 38000 mAh at a nominal voltage of 52.22 V.

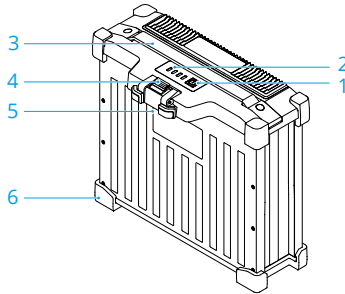

### 1. Power Button

Press to check the battery power level. Press and then press and hold to power on the battery after inserting it into the aircraft. Only power the battery on and off when it is securely connected to the aircraft. Otherwise, the power ports on the battery and the aircraft may be damaged.

### 2. Status LEDs

Indicate the battery level. From left to right: LED 1, LED 2, LED 3 and LED 4.

### 3. Handle

Use the handle to carry the battery.

### 4. Clamp

Use the clamp to firmly secure the battery to the aircraft. The clamp has two stops, press down the battery hard to make sure battery is mounted firmly. Press and hold the clamp to remove the battery from the aircraft.

### 5. Power Port

Connects to an aircraft or a battery station.

### 6. Rubber Caps

Protects the battery.

## Battery Features

The DB2000 Intelligent Flight Battery has the following features:

1. **Battery Level Display:** The status LEDs indicate the current battery level. Press the power button to check.
2. **Communication:** The battery parameters including the voltage and power level are transmitted to the aircraft to enable the aircraft to take appropriate action when battery parameters change.
3. **Battery Error Self-Diagnosis:** The battery can detect errors such as abnormal voltage, current, and temperature, and issue an alert. The error information will be recorded in the battery.
4. **Short Circuit Detection:** After the battery is inserted into the aircraft and powered on, the battery will first detect if a short circuit exists on the aircraft. If detected, the battery will cut off power supply to the aircraft to avoid a fire.
5. **Charging Error Detection:** Errors that occur during charging are indicated by the status LEDs. When an error occurs, wait for the battery to fix the error automatically. For more information, refer to the LED Patterns section.
6. **Auto Balancing:** In certain situations, the battery automatically balances the voltages of the cells.
7. **Auto Discharging:** If fully charged for more than one day, the battery automatically discharges to 95%. After 7 days (can be set by user), it automatically discharges to 60%.
8. **Auto Current Adjustment:** The battery intelligently adjusts the charging current based on the temperature of the battery cells. The battery also supports self-protection based on the environment temperature.
9. **Temperature Control:** The battery ensures the temperature difference between the battery cells are the same and stay within the allowable temperature range. The feature ensures the battery operates normally at a low temperature.



- Refer to the safety requirements listed on the label of the battery before using for the first time. Users shall take full responsibility for all operation and usage.
  - The product warranty is void if any battery errors occur due to misuse of the battery.
-

## Using the Battery

### Charging

Use the C8000 Intelligent Battery Station to charge the DB2000 Intelligent Flight Battery.

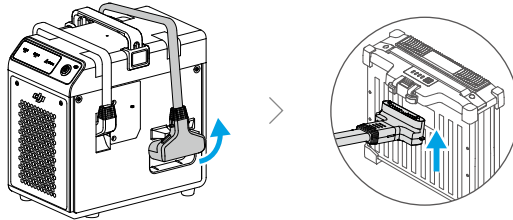

- 
- ⚠ • Only use the C8000 Intelligent Battery Station produced by Shenzhen Gold Power Tech Co., Ltd. to charge DB2000 Intelligent Flight Batteries. DJI does not take any responsibility for damage caused by using non-DJI-specified charging devices.
- 

### Using Paired Batteries

Label the two batteries with paired battery stickers before use. Charge and discharge the two batteries together to optimize flight performance and maximize battery life. After the batteries are inserted and the aircraft is powered on, if there is a significant difference in the battery life of the two batteries, the app will display a prompt alerting the user to the condition of the batteries. It is recommended to replace them with batteries with similar performance levels before use.

### Powering On/Off

- 
- 💡 • A battery cannot be powered on before inserting it into the aircraft.
- 

Install the batteries in the aircraft before powering on or off. Press the power button, then press again and hold for two seconds to power on the battery. Once a battery is powered on, the other battery will power on after that. Press the power button, then press again and hold to power off the batteries after flight. After the motor stops, disconnect the batteries from the aircraft.

### Battery Hot Swapping

After landing, the aircraft does not have to be powered off when swapping its batteries. Insert a fully charged battery and wait for three seconds before inserting the other battery. Battery Hot Swapping needs to be enabled in DJI Pilot 2 and is only supported when using dual battery mode. Tap **•••••** > **🔋** > Battery Hot Swapping to enable.

- 
- ⚠ • DO NOT use the battery hot swapping method on a rainy day.
  - The battery will power off automatically if performing battery hot swapping without having first enabled it in DJI Pilot 2.
-

## Single and Dual Battery Mode

The FlyCart 30 aircraft supports single and dual battery mode. Dual battery mode is used by default. Single battery mode needs to be enabled in DJI Pilot 2 before use.

1. It is recommended to use the front battery compartment for single battery flight. Mount the provided battery cover onto the battery compartment not in use to protect the battery port. The aircraft cannot be powered on without mounting the battery cover.
2. Enable single battery mode in DJI Pilot 2: Tap **•••** >  > Single Battery Flight.

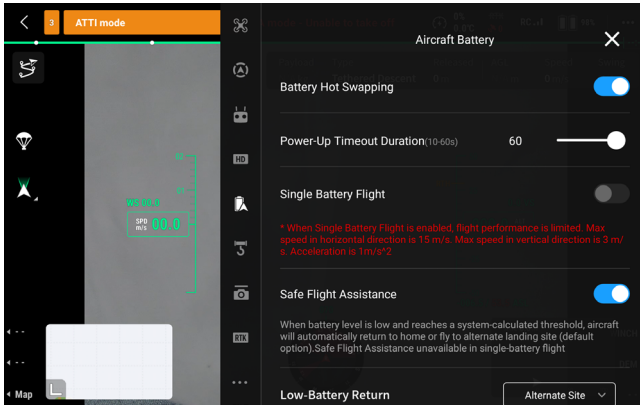

- ⚠ • In dual battery mode, if the battery LEDs did not light up after powering on, unplug and plug the battery to ensure it is mounted firmly. Take off only after all the battery LEDs are lit up normally. Otherwise, the operation time will be reduced significantly. If the LEDs are still off, replace the battery with another battery.
- Only use single battery mode in special situations. The max payload can be increased but the operation time will be reduced in single battery mode.

## Self-Heating

The battery has a built-in self-heating feature to be used when operating in low-temperature conditions:

1. When the battery temperature is lower than 10° C (50° F), self-heating starts once the battery is inserted into the aircraft and powered on. It is recommended to operate the battery after self-heating turns off. Self-heating will turn off automatically after takeoff.
2. If the battery is not in the aircraft, press and hold the battery level button for five seconds to initiate self-heating. The battery will continue to keep warm with a temperature between 10° to 12° C (50° to 53.6° F) for approximately 30 minutes. Press and hold the power button for five seconds to stop self-heating.
3. When the battery temperature is lower than 20° C (68° F), connect the battery to the battery station and power it on. The battery will be heated and powered by the battery station.

## Low-Temperature Notice

1. The performance of the Intelligent Flight Batteries are significantly reduced when flying in low-temperature environments (temperatures below 10° C (50° F)). Ensure that batteries are fully charged before each flight.
2. End the flight as soon as DJI Pilot 2 displays the Low Battery Level Warning in low-temperature environments. You will still be able to control the movement of the aircraft during auto landing, such as pushing the throttle stick to ascend.
3. In extremely cold weather, the battery temperature may not be high enough even after warming up. In these cases, insulate the battery as required.
4. To ensure optimal performance of the battery, keep the battery temperature above 10° C (50° F). A battery temperature above 20° C (68° F) will ensure good performance.
5. In low-temperature environments, it will take a longer time for the batteries to warm up. It is recommended to keep the battery warm before use to reduce the warm-up time.



- DO NOT store, use, transport or leave the batteries near heat sources such as a furnace or heater, or inside a vehicle on hot days.
- DO NOT allow the batteries to come into contact with any kind of liquid. DO NOT use the batteries in the rain or in any other humid environment. If the inside of a battery comes into contact with water, chemical decomposition may occur, potentially resulting in the battery catching on fire and possibly leading to an explosion.
- DO NOT use swollen, leaking, or damaged batteries. If there is anything abnormal with your battery, contact an authorized DJI dealer for further assistance.
- Make sure the battery is powered off before connecting to or disconnecting from the aircraft. DO NOT connect or disconnect the battery while it is powered on. Otherwise, the power ports may be damaged.
- The battery should be used in the temperature range of -20° to 45° C (-4° to 113° F). Use of batteries in environments above 50° C (122° F) can lead to fire or an explosion.
- DO NOT use the battery in strong electrostatic or electromagnetic environments or near high-voltage transmission lines. Otherwise, the battery circuit board may malfunction, which could cause a serious flight hazard.
- DO NOT disassemble or pierce the batteries in any way. Otherwise, the batteries may leak, catch fire, or explode.
- Electrolytes in batteries are highly corrosive. If any electrolytes come into contact with your skin or eyes, immediately wash the affected area with running water for at least 15 minutes and see a doctor immediately.
- DO NOT use batteries that have been dropped.
- If the battery comes into contact with water while the aircraft is flight or the battery drops from the aircraft, remove it immediately, and contact a DJI authorized dealer to check and repair the aircraft and Intelligent Flight Battery as soon as possible.
- Extinguish any battery fire using water, sand, or a dry powder fire extinguisher.
- DO NOT put a battery in a microwave oven or a pressurized container.
- DO NOT connect the positive and negative poles of a battery with a cable or other metal objects. Otherwise, the battery will short-circuit.



- DO NOT drop or strike batteries. DO NOT place heavy objects on the batteries or charging station.
- Always use a clean, dry cloth when cleaning the battery terminals. Otherwise, this may affect the battery connection, resulting in energy loss or failure to charge.
- DO NOT fly when the battery power level is below 15% to avoid damage to the battery and flight risks.
- Make sure the battery is correctly connected. Otherwise, the battery may overheat or even explode due to abnormal charging. Only use approved batteries from authorized dealers. DJI assumes no responsibility for any damage caused by using batteries that are unapproved.
- Make sure to lift the battery by the handle.
- DO NOT place anything on a battery. Otherwise, the battery may be damaged, which may lead to fire hazards.
- The battery is heavy. Be careful when moving the battery to avoid dropping it. If the battery is dropped and damaged, immediately leave the battery in an open area away from people. Wait 30 minutes and soak the battery in water for 24 hours. After making sure the power has completely run out, dispose of the battery in accordance with local laws.



- Make sure the battery is fully charged before each flight.
  - Immediately land the aircraft if a critical battery level warning appears and replace with a fully charged battery.
-

































## LED Patterns

 The Battery Level Indicators will show the current battery level and status during charging and discharging. The indicators are defined below:

 is on    is blinking    is off





















## Checking the Battery Level

If the battery is in power-saving mode, press the power button once to check the current battery level.

LED1	LED2	LED3	LED4	Battery Level
				88%~100%
				75%~87%
				63%~74%
				50%~62%
				38%~49%
				25%~37%
				13%~24%
				0%~12%













## LED Patterns During Charging

During charging, the LEDs blink in sequence to indicate the current battery level. All the LEDs will be off after a full charge. Disconnect the battery when charging is complete, and always use the officially recommended charging device to charge the battery.

LED1	LED2	LED3	LED4	Battery Level
				0%~49%
				50%~74%
				75%~89%
				90%~99%
				100%

## Battery Error LED Patterns

The table below shows battery protection mechanisms and corresponding LED patterns.

LED1	LED2	LED3	LED4	Blinking Pattern	Descriptions
				LED2 and LED4 blink three times per second	Aircraft short circuit/ overcurrent at power on
				LED2 and LED4 blink two times per second	Under-voltage at power on
				LED2 blinks twice per second	Overcurrent detected

				LED2 blinks three times per second	The battery system is not working properly
				LED3 blinks twice per second	Overcharge detected
				LED3 blinks three times per second	Charging device over-voltage
				LED4 blinks twice per second	Temperature is too low when charged/powered on
				LED4 blinks three times per second	Temperature is too high when charged/powered on
				All 4 LEDs blink fast	The battery is not working properly and cannot be used

If overcurrent at power on is detected or a short circuit occurs, unplug the battery, then check if there are foreign objects in the port. If under-voltage at power on is detected, charge the battery before use.

If the battery temperature is abnormal, wait for the temperature to return to normal. The battery will then automatically power on or resume charging.

For other situations, after resolving the issue (overcurrent, short circuits, excess battery voltage due to overcharging, or excess charging device voltage), press the power button to cancel the LED indicator protection alert and unplug and plug in the charger again to resume charging.

## Other Statuses

LED1	LED2	LED3	LED4	Blinking Pattern	Descriptions
				LED1/4 blinks in alternate	Maintaining temperature
				LED1/2 and LED3/4 blinks in alternate	Auto-heating
				LED2 solid on, LED3 blinks	Firmware updating
				LED2/3 blinks	Firmware update failed

- ⚠ • DO NOT charge the battery near flammable materials or on flammable surfaces such as carpet or wood. DO NOT leave the battery unattended during charging. There should be a distance of at least 30 cm between the battery station and any charging batteries. Otherwise, the battery station or charging batteries may be damaged by excessive heat and this may even lead to a fire hazard.
- The battery temperature will be high after flight. Wait to charge the battery until it cools down to room temperature. Otherwise, charging may be disabled. Charge the battery at a temperature range of 0° to 60° C (32° to 140° F). The ideal charging temperature range is 22° to 28° C (72° to 82° F). Charging within the ideal temperature range can prolong battery life.
- DO NOT immerse the battery in water to cool it down or when it is charging. Otherwise, the battery cells will corrode causing serious damage to the battery. The user accepts full responsibility for any damage to the battery caused by immersing the battery in water.
- Regularly check the terminals and battery ports. DO NOT clean the battery using alcohol or any other flammable liquid. DO NOT use a damaged charging device.
- Keep the battery dry during charging.

- The battery stops charging when charging is complete. It is recommended to disconnect the battery once charging is complete.
- Make sure the battery is powered off before charging. Otherwise, the battery ports may be damaged.

## Battery Storage

The battery power self-discharges to 95% for the first time after one day when the battery is fully charged and the self-discharge process takes 15 hours. The second battery self-discharge period begins from the seventh day by default (can be set in DJI Pilot 2, minimum times is one day) and self-discharges to 60% battery level to extend the battery life. The self-discharge process takes eight days.

The battery self-discharge strategy is shown below. The days set by user shown in blue.

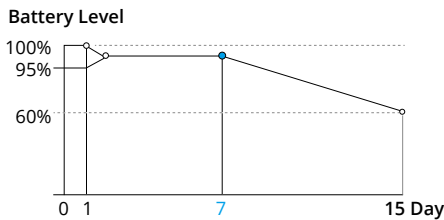

Storing power at proper levels can extend battery life. For long-term storage, storing the battery at a level of 30% or above of full capacity and charging the battery every five months is recommended.

- ⚠ • DO NOT store the battery in a place where the temperature is outside the range of -20° to 45° C (-4° to 113° F). If storing the battery for more than three months, it is recommended to store the battery in a battery safety bag in an environment in a temperature range from -20° to 40° C (-4° to 104° F). Battery life will be reduced if storing the battery at high pressure. It is recommended to shorten the second battery self-discharge period in the app.
- DO NOT store a battery for an extended period after fully discharging. Otherwise, the battery may over-discharge and cause irreparable damage to the battery cell.
- The battery enters hibernation mode if depleted and stored for an extended period. Recharge the battery to bring it out of hibernation.
- Keep batteries out of the reach of children and animals. Seek professional medical support immediately if children swallow parts of the battery.
- Battery performance will be negatively affected if the battery is not used for an extended period.
- Fully charge and discharge the battery every three months to maintain battery health.
- If a battery has not been charged or discharged for five months or more, the battery will no longer be covered by the warranty.

## Transportation

Disconnect the battery from the aircraft and check if there is any buildup in the battery port.

- ⚠ • Power off and disconnect the battery from the aircraft or other devices during transportation.
- If the battery level is critically low, charge the battery to a power level of 25%. DO NOT store a battery with a low power level for an extended period. Otherwise, the performance will be negatively affected.
- The battery must be stored in a dry environment.
- DO NOT place the battery near explosive or hazardous material or near metal objects such as eyeglasses, watches, jewelry, and hairpins.
- DO NOT attempt to transport a battery that is damaged or has more than 30% power. Discharge the battery to 25% or lower before transportation.
- Make sure the battery is placed on a flat surface to avoid damage to the battery from sharp objects.

## Battery Maintenance

Perform battery maintenance once every 200 cycles or three months or when prompted to do so by DJI Pilot 2, by following these steps:



Charge to 100%



Rest for one hour



Discharge to below 20%



Rest for one hour



Charge to 100%

## Battery Disposal

- ⚠ • Before disposing, make sure to soak the battery in water for 72 hours to completely discharge the battery. Dispose of the battery in specific battery recycling boxes. The battery contains hazardous chemicals, DO NOT dispose of the battery in a regular waste disposal container. Strictly follow your local regulations regarding the disposal and recycling of batteries.
- If the battery cannot be discharged completely, DO NOT dispose of the battery in a battery recycling box directly. Contact a professional battery recycling company for assistance.

## Delivery

The cargo system is suitable for delivering small volumes of cargo. Manual flight or a flight route can be selected when delivering the cargo. The cargo delivery process is as follows.

- 
-  FlyCart 30 supports a winch system (sold separately). Refer to the DJI FlyCart 30 Winch System user guide for more information.
- 

## Operation Requirements

1. DO NOT fly the aircraft above people. Keep more than 10 m distance between the aircraft and people. Stay away from the rotating propellers.
2. DO NOT fly in cities and towns.
3. Select open, flat areas for takeoff and landing points. Check and make sure the area is free of any objects. DO NOT take off or land on the road with people.
4. Check if the frame arm locks are securely in the lock position after unfolding the aircraft. Check if the propellers are tightened properly on the motors and in good condition. Make sure the battery port has no black oxidization marks or rust.
5. If the weight value is over 0 when there is no cargo on board, weight calibration is needed. The cargo should be placed in the middle of the cargo case and fixed securely. Make sure the cargo does not exceed the payload capacity by checking if there are any DJI Pilot 2 warnings. Also, make sure there is no center of gravity warning. When the red icon appears, the cargo position should be adjusted. When there is cargo with a shifting center of gravity, the cargo should be moved toward the front of the case.
6. Make sure the cargo case lock is in the appropriate position when opening or closing the cargo case. Pull out to open or lock.
7. Operators must wear a helmet.

## Cargo Case Weight Calibration

If the weight value is over 0 when there is no cargo on board, calibration is needed.

### Calibration Process

1. Place the aircraft on flat ground and make sure the cargo case is empty.
2. Tap **••••** >  > Weight Sensor Calibration in the camera view of DJI Pilot 2.

- 
-  Add cargo into the cargo case after calibration is successful.
  - It is recommended to calibrate the weight sensor every month to ensure sensor accuracy.
-

## Manual Operation

1. After securing the cargo and finishing the preflight checks, control the aircraft during manual takeoff and then fly to the destination.
2. When the aircraft reaches the destination, keep about 10 m between the ground and the bottom of the cargo case. Tilt the FPV gimbal downward, and the AR projection will allow the user to see the situation on the ground.
3. Make sure the surroundings are safe and the area is suitable for landing, then land the aircraft and take out the cargo.

## Cruise Control

After pressing the C3 button during flight, the aircraft will enter cruise control and fly automatically, and no operation is needed. Press the C3 button again to exit cruise control.

## Dual Operation Mode

Set the remote controller at the takeoff point to A and the remote controller at the destination point to B. If the signal strength is weak or the landing condition is complicated, remote controller B can obtain flight control to control the aircraft when it is in sight.

## Usage

1. Set the remote controller to A or B on the homepage of DJI Pilot 2.

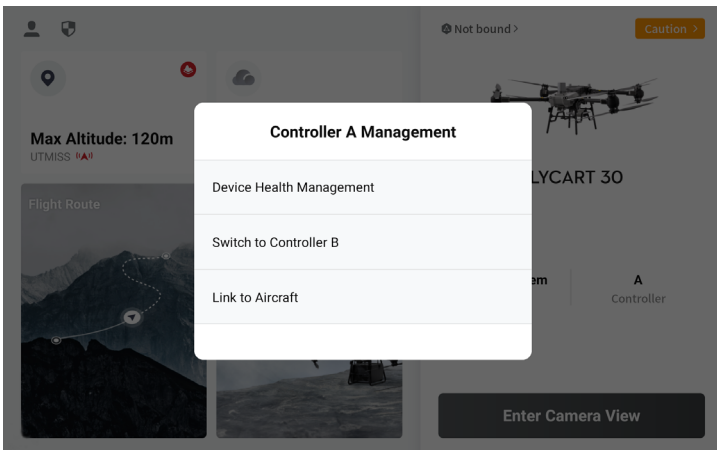

2. Press once on the aircraft authority button of remote controller B. When the indicator turns green, it indicates that aircraft control has been obtained and remote controller B is able to control the aircraft.



- Press and hold the aircraft authority button of remote controller A to lock the aircraft control. When the indicator turns blue, the indicator on remote controller B will blink white, which indicates that remote controller B cannot obtain aircraft control. Press once on the aircraft authority button of remote controller A to release the aircraft control lock.

## Flight Route Operation

The aircraft can fly and deliver cargo to the destination automatically when using a Flight Route.

1. Tap Flight Route on the homepage of DJI Pilot 2 to access the flight route library, and then select a flight route.

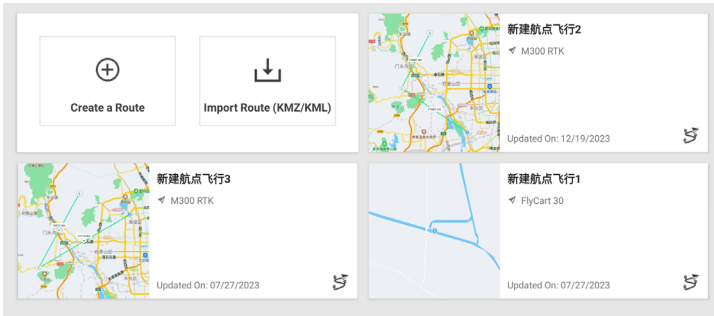

2. Tap  to enter Preflight Check.

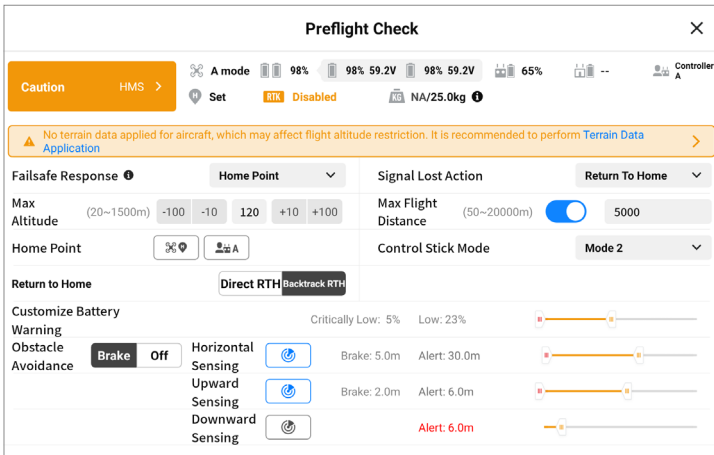

3. Tap Next to enter flight route check. If any warnings appear, make sure to adjust the settings as needed. Upload the flight route after there are no more warnings. Tap Start to start the flight route. The aircraft will deliver the cargo automatically.

-  If there is any emergency during flight, press the flight pause button to brake and hover. The aircraft can continue flight from the brake point.
- If there is an emergency, users can open the parachute to protect the aircraft and cargo, reducing loss. When the aircraft detects a critical error, the parachute will open automatically.



# Updating Firmware

Use DJI Pilot 2 or DJI Assistant 2 (Delivery Series) to update the remote controller, aircraft, and other connected DJI devices.

## Using DJI Pilot 2

### Online Updating

1. Power on the remote controller and aircraft. Ensure the aircraft is properly linked to the remote controller, their battery levels are higher than 25%, and the remote controller is connected to the internet.
2. Run DJI Pilot 2. A prompt will appear on the homepage if new firmware is available. Tap to enter the Firmware Update view.
3. Tap Update All and DJI Pilot 2 will download the firmware and update the aircraft and remote controller.
4. The aircraft and remote controller will automatically restart after the firmware update is complete.



- The update takes approximately 10 minutes (depending on network strength). Make sure the remote controller is connected to the internet during the whole update process.
- The DB2000 Intelligent Flight Batteries in the aircraft will be updated to the latest firmware version.

### Offline Updating

An offline firmware package can be downloaded from the DJI official website to an external storage device such as a microSD card or USB stick. Run DJI Pilot 2, tap HMS, and then Firmware Update. Tap Offline Update to select the firmware package of the remote controller or aircraft from the external storage device and tap Update All to update.

## Using DJI Assistant 2 (Delivery Series)

1. Connect the aircraft and remote controller to the computer separately, as the DJI Assistant 2 does not support updating multiple DJI devices at the same time.
2. Make sure the PC is connected to the internet and the DJI device is powered on with a battery level higher than 25%.
3. Launch DJI Assistant 2 and log in with a DJI account.
4. Tap the firmware update button on the left side of the main interface.
5. Select the firmware version and click to update. The firmware will be downloaded and updated automatically.
6. When the "Update successful" prompt appears, the device update is complete, and the DJI device will restart automatically.



- The battery firmware is included in the aircraft firmware. Be sure to update the firmware of all the batteries.
  - Make sure all DJI devices are properly connected to the PC during an update.
  - During the update process, it is normal for the aircraft LEDs to blink, and the aircraft to reboot. Wait patiently for the update to complete.
  - Make sure to keep the aircraft away from people and animals during a firmware update, system calibration or parameter configuration.
  - Make sure you are using the latest firmware version to ensure flight safety.
  - After the firmware update is completed, the remote controller and the aircraft may become unlinked. Re-link them if necessary.
-

# DJI DeliveryHub

DJI DeliveryHub is a cloud-based management platform for delivery drones. It helps manage and monitor flight tasks remotely, but flight route planning and data management are also supported.



- Using DJI DeliveryHub is optional, as deliveries can be made without it.

## UI Features

### Tasks

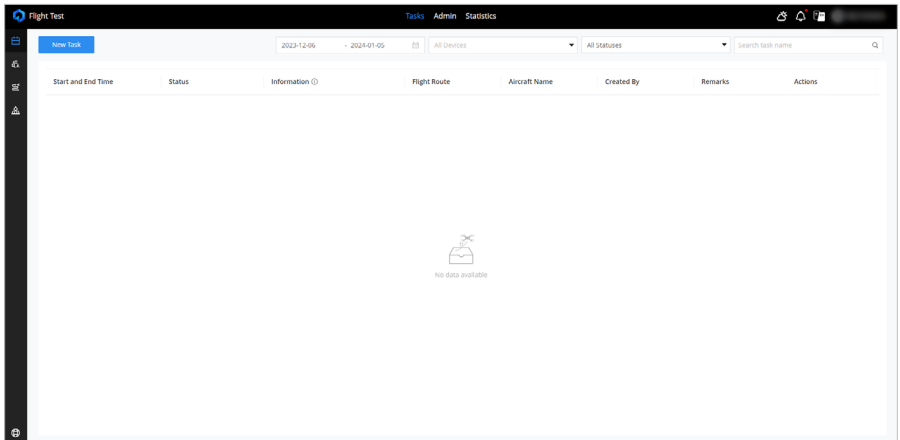

Click the left menu to access the following pages.

#### Task List

Tap New Task to create. Can filter by task status within a specified period, task status of a specified aircraft, and the status of flight routes for a task. Select Start and End Time to view the task process and status. Information shows the task-related information such as payload, flight distance and duration, the max wind speed and consumed battery power. Click Actions to edit a task. Click the Copy icon to copy the task and then it can be performed again.

#### Task Tracking

View the number of aircraft online as well as number of total aircraft. Can also view tasks online and total tasks here. The online and offline aircraft number, aircraft status during a task, online standby aircraft numbers, online users and their names can be viewed here as well.

#### Flight Route

Checking the flight route by time is supported. Click Import to import the KMZ file to

DeliveryHub. Click + to create a new flight route on the map. Flight route list shows flight route distance and duration. User and time can be updated. Click the flight route to view on the map. Drag the mouse while holding the CTRL button to preview the flight route in 3D. If there is more than one flight route, select all the flight routes required and they can be viewed in 3D simultaneously. Tap the Edit or More icon to adjust the flight route.

## Map Elements

View marked locations. Locations list supports view by time, and can be added to My Favorites or searched. Tap + to add new location. Select a location to quickly switch between flight areas. Alternate sites can be added or edited. Tap alternate site for more information.

## Admin

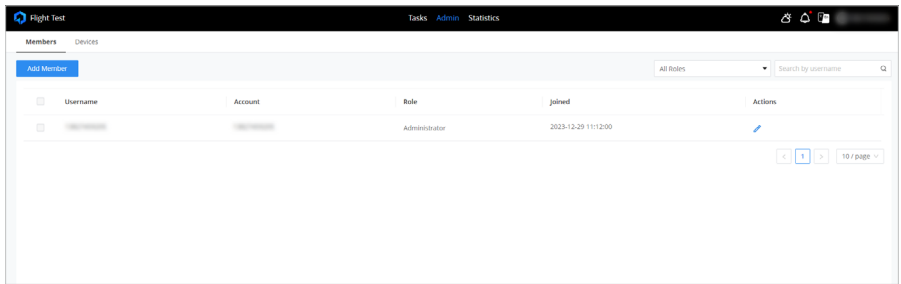

## Members

A team needs to be created when logging in to the DeliveryHub for the first time. After a team is created, member settings will be available. The user that created the team has Administrator rights.

Select Add Member to add a DJI account and set the member name and role. Role can be set to Administrator or Member. Administrator has all management rights and Member only has some of those rights. Tap Confirm to add a member after confirming all the settings. Upload an Excel file when adding many members. Download the Excel template to add members. To add an aircraft, use a previously added DJI account.

## Devices

Can view the profile of the aircraft and perform the following operations:

- Edit device name.
- View aircraft data and maintenance items.
- Check all warnings.
- Delete device.

## Statistics

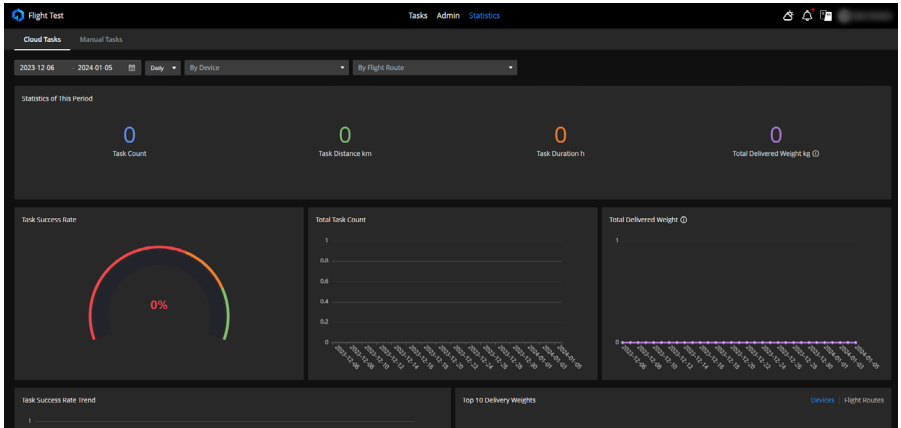

Check the statistics of a period for a team, an aircraft or a flight route.

## Using DeliveryHub

### Log In

Visit <https://dh.dji.com> to start using DeliveryHub. A DJI account is required.

### Create Team

A team needs to be created if there is no team yet. Input the team name and set a location for the team on the map to complete creation. After the team is added, it will be added to Task Tracking immediately.

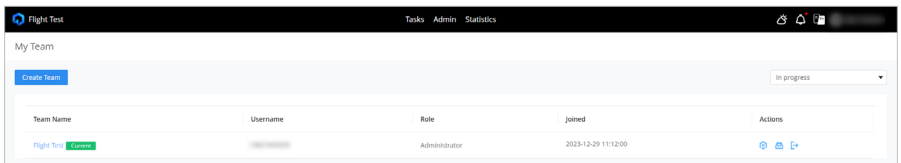

## Binding the Team and the Aircraft

After binding the team and the aircraft, the aircraft status can easily be shared with the team on DeliveryHub.

Ensure the aircraft and the remote controller connections are normal. On the homepage of DJI Pilot 2, tap Cloud Service, and then log in to DeliveryHub using a DJI account. Select a team and bind the team with the aircraft. Binding can be undone via the remote controller or an operation in Basics in DeliveryHub.

After the binding is finished, flight routes saved in DJI Pilot 2 can be uploaded to the team files, and team flight routes can be downloaded to the remote controller.

## Create a Route

1. Select Location in the Task page. Select a location related to the flight route or search for the flight area.

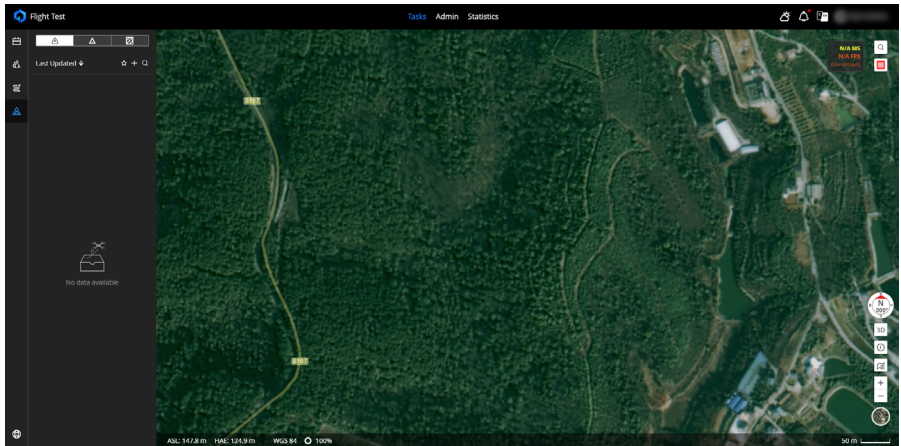

2. Select Flight Route Library after confirming a flight area.



Tap + to add waypoint. The following settings can be set for flight routes.

Flight Route Name	It is recommended to name the flight route using the location name.
Safe Takeoff Altitude	Safe Takeoff Altitude is altitude relative to takeoff point altitude. When the Safe Takeoff Altitude is higher than the flight route altitude, the aircraft will ascend to the Safe Takeoff Altitude and fly to the takeoff point, then descend to the start point of the flight route. When the Safe Takeoff Altitude is lower than the flight route altitude, the aircraft will ascend to the Safe Takeoff Altitude and then ascend to the flight route altitude, and fly to the start point.
Direct Routing	When enabled, the aircraft will ascend to the Safe Takeoff Altitude and fly straight to the start point.
Attitude Mode	It is recommended to select ALT.
Speed	The horizontal flight speed during the flight route.
Upon Completion	Set to Hover or Land.
On Signal Lost	Set to Continue Task, Return to Home, Land, Hover.
Waypoint Type	Set the action taken when the aircraft flies past the waypoint. It is recommended to use Turns before Waypoint. Flies through.

3. Click the left button of the mouse to add a waypoint, click the right button to add or delete a waypoint. The map shows the flight route distance, estimated duration and the waypoint information. Tap the waypoint to move, tap < or > to edit the next waypoint. It is recommended to select Follow Route.
4. Edit flight route via map.
  - a. Compass shows the map direction.
  - b. Tap to switch to 2D or 3D view.
  - c. Display the flight area and Restricted Areas.
  - d. Select show elements.
  - e. Zoom in or out of the map.
  - f. Check the flight altitude in elevation layer view. If the waypoint is too low, adjust the altitude on the map. Drag the mouse up or down while pressing the ALT key to adjust the altitude. Press the left button of the mouse while pressing the CTRL key to adjust the view.
5. Tap Save to complete flight route plan. Start point and end point can be linked later.

# Perform Task

## 1. Create Task

Tap Task > Task List to create a task. Select a flight route, device and view the status of the aircraft. Tap Confirm to complete.

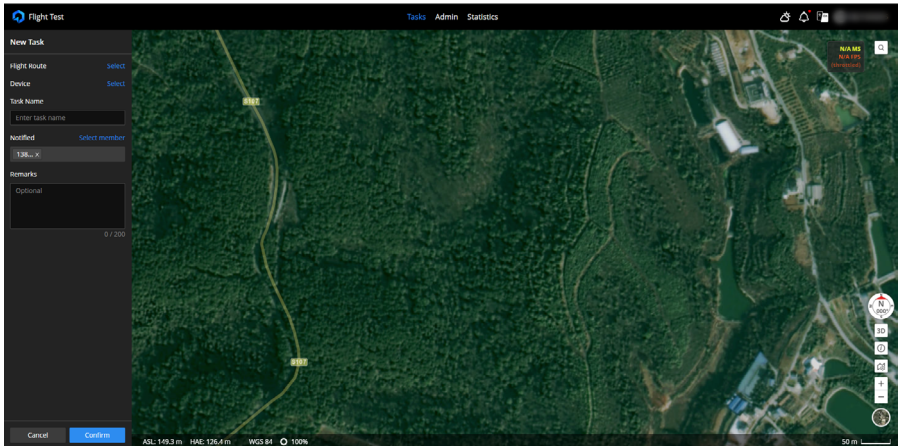

## 2. Perform Task

In the task list, tap the takeoff icon. The aircraft will start a self-check. Select confirm after self-check is finished. Before taking off for the first time, DeliveryHub needs to obtain permission from the remote controller at the takeoff point. The user at the takeoff point needs to confirm in DJI Pilot 2 when there is a prompt. The aircraft can take off after permission of cloud which last for seven days is given.

## 3. Task Tracking

View the task status in the Task Tracking page. Tap the icon to check the aircraft information. Tap FPV to view the FPV camera view. The user at the start point can check the Cloud Service status in DJI Pilot 2 homepage and camera view.

If the cloud service is not connected or the icon turns gray, this means the connection is abnormal. Check the network of the remote controller.



# Supplements

## Specifications

### Aircraft

Weight	42.5 kg (without battery) 65 kg (with two DB2000 batteries)
Max Takeoff Weight	95 kg (with cargo case, at sea level)
Max Diagonal Wheelbase	2200 mm
Dimensions	1590 x 1900 x 947 mm (L x W x H) (arms unfolded, propellers folded)
Dimensions	2800 x 3085 x 947 mm (L x W x H) (arms & propellers unfolded)
Dimensions	1115 x 760 x 1027 mm (L x W x H) (arms & propellers folded)
Folding Method	Towards body
Loadable Battery Quantity	2
Hovering Endurance (empty weight, with max battery capacity)	29 mins (dual battery mode) 15 mins (single battery mode) The data was measured in controlled conditions: zero altitude and windless environment, for reference only.
Hovering Endurance (max weight, with max battery capacity)	18 mins (30 kg weight load, dual battery mode) 8 mins (40 kg weight load, single battery mode) The data was measured in controlled conditions: zero altitude and windless environment, for reference only.
Max Flight Distance (empty weight, with max battery capacity)	28 km (dual battery mode) 12 km (single battery mode) The data was measured in controlled conditions: zero altitude and windless environment, at a constant speed of 15 m/s.
Max Flight Distance (max weight, with max battery capacity)	16 km (30 kg weight load, dual battery mode) 8 km (40 kg weight load, single battery mode) The data was measured in windless, zero altitude experimental environment, at a constant speed of 15 m/s, for reference only.
Max Flight Time (max weight, with max battery capacity)	18 mins (30 kg weight load, dual battery mode) 9 mins (40 kg weight load, single battery mode) The data was measured in windless, zero altitude experimental environment, at a constant speed of 15 m/s, for reference only.
Operating Temperature	-20° to 45° C (-4° to 113° F)
Ingress Protection Rating	IP55
Hovering Accuracy (with strong GNSS signal)	RTK positioning enabled: ±10 cm horizontal, ±10 cm vertical RTK positioning disabled: ±60 cm horizontal and ±30 cm vertical

RTK/GNSS Operating Frequency	RTK: GPS L1/L2, Galileo F1/F2, BeiDou B1I/B2I/B3I, Galileo E1/E5b, QZSS L1/L2 GNSS: GPS L1, BeiDou B1I, Galileo F1, Galileo E1, QZSS L1
Max Pitch Angle	30°
Max Ascent Speed	5 m/s The data was measured in an experimental environment with zero altitude and no wind, with 30 kg load weight, for reference only.
Max Descent Speed	3 m/s (vertical) 5 m/s (tilted descent) The data was measured in an experimental environment with zero altitude and no wind, with 30 kg load weight, for reference only.
Max Horizontal Speed	20 m/s The data was measured in an experimental environment with zero altitude and no wind, with 30 kg load weight, for reference only.
Max Takeoff Altitude	6000 m (empty weight)
Max Wind Speed Resistance	12 m/s The data was measured in an experimental environment with zero altitude, with 30 kg load weight, for reference only.
<b>Power System</b>	
Stator Size	100 x 33 mm
Motor KV Value	48 rpm/V
Max Motor Power	4000 W/rotor
Propellers Material	Carbon fiber composite
Propellers Diameter	54 inch
Propellers Type	Foldable double-blade propeller
Main-rotor Diameter	1375 mm
Rotor Quantity	8
<b>LED Light</b>	
Effective Illumination Distance	10 m
Illumination Mode	60 Hz, automatically switch on according to ambient light
<b>DJI O3 Image Transmission</b>	
Model	Pigeon (with DDR)-2T4R
Signal Effective Distance	20 km (FCC) 8 km (CE/SRRC/MIC) Measured in an unobstructed environment with no interference
Operating Frequency	2.4000-2.4835 GHz 5.725-5.850 GHz Some countries or regions do not support the 5.8 GHz frequency band. Please refer to local flight laws and regulations for details.

EIRP	2.4000 GHz-2.4835 GHz: <33 dBm (FCC) <20 dBm (CE/SRRC/MIC)
	5.725 GHz - 5.850 GHz: <33 dBm (FCC) <30 dBm (SRRC) <14 dBm (CE)
Data Security	AES-256
ADS-B	Supported
<b>Active Phased Forward and Backward Array Radar</b>	
Model Number	RD241608RF (forward) RD241608RB (backward)
Altitude Detection	Fixed altitude range: 1.5-200 m
Rear Obstacle Avoidance	Sensible distance (rear): 1.5-50 m FOV: Forward: 360° horizontal, ±45° vertical, ±45° upward Backward: ±45° horizontal, 360° vertical Operating conditions: Available during takeoff, landing, and ascending when an obstacle is more than 1.5 m away from the aircraft Safe distance: 3.5 m (distance between the propeller tip and obstacle when the aircraft is hovering after braking) Sensing direction: multi-direction
<b>Binocular Vision System</b>	
FOV	Horizontal: 90; Vertical: 106°
Work Environment Requirements	Non-reflective, discernible surfaces with diffuse reflectivity of >20%, such as concrete or tarmac. Adequate lighting of lux >15 Surface with a clear pattern
<b>FPV Camera</b>	
Resolution	1920 x 1440
DFOV	149°
Frame Rate	30fps
Type	Full HD FPV Single Axis Gimbal Camera
Fill Light	Supported
<b>Cargo Case</b>	
Dimensions	754 x 472 x 385 mm (L x W x H)
Inner Space	573 x 416 x 306 mm (L x W x H)
Material	EPP plus aluminum alloy frame
Weighing Feature	Supported
Weight	Approx. 3 kg
Load Capacity	0-40 kg

<b>Parachute</b>	
Max Load	95 kg
Dimensions	300 x 200 x 120 mm (L x W x H)
Weight	Approx. 2.1 kg
Automatic Reaction Time	Approx. 1000 ms
Descending Speed	≤ 6m/s (at sea level, no wind)
Parachute Shape	Square
Material	Nylon
Surface Area	Approx. 22 m <sup>2</sup>
Minimum Opening Height	60 m
Operating Temperature	-20° to 45° C (-4° to 113° F)
Ingress Protection Rating	IP55
Mainboard Power-off Battery Life	≥ 1 hour
Memory Card Capacity	Real-time record for 10 flights
Buzzer Alarm	Supported
Lighting Alarm	Supported
Manually Opening	Supported
Automatic Opening	Supported
<b>DJI DB2000 Intelligent Flight Battery</b>	
Model	DB2000
Capacity	38000 mAH
Nominal Voltage	52.22 V
Type	14S1P
Energy	1984.4 Wh
Weight	Approx. 11.32 kg
Installation Method	Plug
Dimension	316 x 152 x 279 mm (L x W x H)
Operating Temperature	-20° to 45° C (-4° to 113° F)
Charging Rate	5° to 15° C: 1.0C 15° to 45° C: 2.5C
Max Charging Power	5700 W
Automatic Heating Feature	Supported (when the battery temperature is below 10° C, pressing and holding the button or turning on the drone will activate the self-heating function. When the battery temperature is below 20° C, connecting the charger to the battery will activate the self-heating function. Charging and discharging in a low-temperature environment may reduce the battery's lifespan)

**DJI C8000 Intelligent Battery Station**

Model	CHX101-7000
-------	-------------

Input	90-264 V AC
-------	-------------

Output	42-59.92 V DC
--------	---------------

Max Output Power	7200 W (Dual input) 3600 W (Single input)
------------------	--

Output Channel Quantity	2
-------------------------	---

Protection Feature	The feature is designed to reponse to issues including overheat, overvoltage, undervoltage, short circuit, fan stall, etc.
--------------------	--

Operating Temperature	-20° to 45° C (-4° to 113° F)
-----------------------	-------------------------------

Charging Security	Connector protection feature available
-------------------	--

**Remote Controller**

Type	DJI RC Plus
------	-------------

App	DJI Pilot 2
-----	-------------

Operating Frequency	2.4000-2.4835 GHz 5.725-5.850 GHz
---------------------	--------------------------------------

EIRP	2.4000-2.4835 GHz: <33 dBm (FCC) <20 dBm (CE/SRRC/MIC)
------	--

	5.725-5.850 GHz: <33 dBm (FCC) <23 dBm (SRRC) <14 dBm (CE)
--	---

Operating Temperature	-20° to 50° C (-4° to 122° F)
-----------------------	-------------------------------

Charging Environment Temperature	5° to 40° C (41° to 104° F)
----------------------------------	-----------------------------

Built-in Battery Life	3.3 hours
-----------------------	-----------

External Battery	2.7 hours
------------------	-----------

Charging Method	Use a USB-C fast charging charger with a maximum power of no less than 65 W (maximum voltage of 20 V). DJI 100 W USB-C Power Adapter is recommended.
-----------------	--

Charging Time	2 hours with built-in battery, 2.5 hours with built-in and external battery (shutdown status according to official charging method)
---------------	---

Ingress Protection Rating	IP54
---------------------------	------

Video Output Interface	HDMI
------------------------	------

Wi-Fi Protocol	Wi-Fi 6
----------------	---------

Wi-Fi Working Frequency	2.4000-2.4835 GHz 5.150-5.250 GHz 5.725-5.850 GHz
-------------------------	---

Bluetooth Protocol	Bluetooth 5.1
--------------------	---------------

Bluetooth Working Frequency	2.4000-2.4835 GHz
EIRP	<10 dBm
GNSS	GPS+Galileo+BeiDou
Screen	7.02 inch touch LCD display screen, resolution 1920 x 1200, brightness 1200 nits
Dual Control	Supported

## FAR Remote ID Compliance Information

The unmanned aircraft system is equipped with a Remote ID system that meets the requirements of 14 CFR Part 89.

- The aircraft automatically initiates a pre-flight self-test (PFST) of the Remote ID system before takeoff and cannot take off if it does not pass the PFST <sup>[1]</sup>. The results of the PFST of the Remote ID system can be viewed in a DJI flight control app such as DJI Pilot 2.
- The aircraft monitors the Remote ID system functionality from pre-flight to shut down. If the Remote ID system malfunctions or has a failure, an alarm will be displayed in a DJI flight control app such as DJI Pilot 2.
- The user shall keep the DJI flight control app running in the foreground and always allow it to obtain the location information of the remote controller.
- Developers who develop third-party applications based on the DJI Mobile SDK shall obtain and display the PFST results and the failure status of the Remote ID system during operation by calling specific APIs <sup>[2]</sup>.
- Developers who develop third-party platforms based on the DJI Cloud API shall obtain and display the PFST results and the failure status of the Remote ID system during operation by calling specific APIs <sup>[3]</sup>.
- Developers developing payload devices based on DJI PSDK shall read and comply with the requirements in the PSDK's "Flight Safety Notification", and shall not disrupt or degrade the functionality of the Remote ID system. For "Non-RC Flight" developers, they shall send the true and accurate geographic location information of the pilot or operator obtained by appropriate technology to the Remote ID system by calling specific APIs<sup>[4]</sup> provided by the PSDK, and shall obtain and display the PFST results and the failure status of the Remote ID system during operation by calling specific APIs.
- You can visit the official website of FAA to learn more about aircraft registration and Remote ID requirements.

### Footnotes

- [1] The pass criterion for PFST is that the hardware and software of the Remote ID required-data source and transmitter radio in the Remote ID system are functioning properly.
- [2] For detailed APIs information, please visit <https://developer.dji.com/mobile-sdk/>
- [3] For detailed APIs information, please visit <https://developer.dji.com/cloud-api/>
- [4] For detailed APIs information, please visit <https://developer.dji.com/payload-sdk/>



The terms HDMI, HDMI High-Definition Multimedia Interface, HDMI trade dress and the HDMI Logos are trademarks or registered trademarks of HDMI Licensing Administrator, Inc.

WE ARE HERE FOR YOU



Contact  
DJI SUPPORT

This content is subject to change without prior notice.



<https://www.dji.com/flycart-30/downloads>

If you have any questions about this document, please contact DJI by sending a message to **DocSupport@dji.com**.

DJI is a trademark of DJI.

Copyright © 2024 DJI All Rights Reserved.